



MULTIMEDIA PROJECTOR

LV-7385

LV-7380

LV-7285

LV-7280

LV-8310

LV-8215

User's Manual



The projector's model name is of two types, with or without suffix (E) at its end.

The model names are referred to as LV-7385, LV-7380, LV-7285, LV-7280, LV-8310, and LV-8215 respectively throughout the user's manual excluding some of the specifications pages.

Important Information

Safety Cautions

Precautions

Please read this manual carefully before using your Canon LV-7385/LV-7380/LV-7285/LV-7280/LV-8310/LV-8215 projector and keep the manual handy for future reference. Your serial number is located on the bottom of your projector. Record it here:

CAUTION



To turn off main power, be sure to remove the plug from power outlet.

The power outlet socket should be installed as near to the equipment as possible, and should be easily accessible.

CAUTION



TO PREVENT SHOCK, DO NOT OPEN THE CABINET.

NO USER-SERVICEABLE PARTS INSIDE.

REFER SERVICING TO QUALIFIED SERVICE PERSONNEL.



This symbol warns the user that uninsulated voltage within the unit may be sufficient to cause electrical shock. Therefore, it is dangerous to make any kind of contact with any part inside of the unit.



This symbol alerts the user that important information concerning the operation and maintenance of this unit has been provided.

The information should be read carefully to avoid problems.

WARNING: TO PREVENT FIRE OR SHOCK, DO NOT EXPOSE THIS UNIT TO RAIN OR MOISTURE. DO NOT USE THIS UNIT'S PLUG WITH AN EXTENSION CORD OR IN AN OUTLET UNLESS ALL THE PRONGS CAN BE FULLY INSERTED. DO NOT OPEN THE CABINET. THERE ARE HIGH-VOLTAGE COMPONENTS INSIDE. ALL SERVICING MUST BE DONE BY QUALIFIED SERVICE PERSONNEL.

Machine Noise Information Regulation - 3. GPSGV,

The highest sound pressure level is less than 70 dB (A) in accordance with EN ISO 7779.

CAUTION



Avoid displaying stationary images for a prolonged period of time.

Doing so can result in these images being temporarily sustained on the surface of the LCD panel.

If this should happen, continue to use your projector. The static background from previous images will disappear.

CAUTION



Do not put the projector on its side when the lamp is turned on.

Doing so may cause damage to the projector.

WARNING TO CALIFORNIA RESIDENTS:

Handling the cables supplied with this product will expose you to lead, a chemical known to the State of California to cause birth defects or other reproductive harm. *WASH HANDS AFTER HANDLING.*

Federal Communication Commission Notice

Multimedia Projector, Model : LV-7385, LV-7380, LV-7285, LV-7280, LV-8310, and LV-8215

This device complies with Part 15 of the FCC Rules. Operation is subject to the following two conditions:

(1) This device may not cause harmful interference, and (2) this device must accept any interference received, including interference that may cause undesired operation.

Note : This equipment has been tested and found to comply with the limits for a Class B digital device, pursuant to part 15 of the FCC Rules. These limits are designed to provide reasonable protection against harmful interference in a residential installation. This equipment generates, uses and can radiate radio frequency energy and, if not installed and used in accordance with the instructions, may cause harmful interference to radio communications. However, there is no guarantee that interference will not occur in a particular installation. If this equipment does cause harmful interference to radio or television reception, which can be determined by turning the equipment off and on, the user is encouraged to try to correct the interference by one or more of the following measures :

- Reorient or relocate the receiving antenna.
- Increase the separation between the equipment and receiver.
- Connect the equipment into an outlet on a circuit different from that to which the receiver is connected.
- Consult the dealer or an experienced radio/TV technician for help.

The cable with the ferrite core provided with the projector must be used with this equipment in order to comply with Class B limits in Subpart B of Part 15 of the FCC rules.

Use of shielded cable is required to comply with class B limits in Subpart B of Part 15 of FCC Rules.

Do not make any changes or modifications to the equipment unless otherwise specified in the instructions. If such changes or modifications should be made, you could be required to stop operation of the equipment.

Canon U.S.A., Inc.

One Canon Plaza, Lake Success, NY 11042, U.S.A.

Tel No. (516)328-5600

Canadian Radio Interference Regulations

This Class B digital apparatus complies with Canadian ICES-003.

Réglementation canadienne sur les interférences radio

Cet appareil numérique de la classe B est conforme à la norme NMB-003 du Canada.



European Union (and EEA) only.

These symbols indicate that this product is not to be disposed of with your household waste, according to the WEEE Directive (2002/96/EC), the Battery Directive (2006/66/EC) and/or your national laws implementing those Directives.

If a chemical symbol is printed beneath the symbol shown above, in accordance with the Battery Directive, this indicates that a heavy metal (Hg = Mercury, Cd = Cadmium, Pb = Lead) is present in this battery or accumulator at a concentration above an applicable threshold specified in the Battery Directive.



This product should be handed over to a designated collection point, e.g., on an authorized one-for-one basis when you buy a new similar product or to an authorized collection site for recycling waste electrical and electronic equipment (EEE) and batteries and accumulators. Improper handling of this type of waste could have a possible impact on the environment and human health due to potentially hazardous substances that are generally associated with EEE.

Your cooperation in the correct disposal of this product will contribute to the effective usage of natural resources.

For more information about the recycling of this product, please contact your local city office, waste authority, approved scheme or your household waste disposal service or visit

www.canon-europe.com/environment.

(EEA: Norway, Iceland and Liechtenstein)



LAMP HANDLING PRECAUTIONS

This projector uses a high-pressure mercury lamp which must be handled carefully and properly as mentioned below.

- A lamp may explode with a loud sound or burn out due to a shock, scratch, or expiration of lifetime.
- The lamp life may differ from lamp to lamp and according to the environment of use. There is not guarantee of the same lifetime for each lamp. Some lamps may fail or terminate their life in a shorter period of time than other similar lamps.
- A lamp gradually becomes darker with time of use.
- If the projector indicates that the lamp should be replaced (i.e., the LAMP indicator blinks red rapidly), chances of explosion become higher. Replace the lamp with a new one immediately.
- Always keep your face away from the exhaust vent so that you do not suffer from the gas and broken shards of the lamp.



IF A LAMP EXPLODES

If a lamp explodes, the gas and broken shards may scatter inside the projector and they may come out of the exhaust vent. The gas contains toxic mercury.

Open windows and doors for ventilation.

If you inhale the gas or the shards of the broken lamp enter your eyes or mouth, consult the doctor immediately.

If a lamp explodes, its shards may scatter inside the projector. Ask the Canon service representative to clean and check the inside of the projector and replace the lamp.



DISPOSAL OF WASTE LAMP

Dispose of the mercury lamp of the projector according to the local regulation just like the fluorescent lamp.

Lamp Replacement

- To replace the lamp, follow all instructions provided on page [71](#), [72](#), [73](#).
- Be sure to replace the lamp when the message **[Replace with the new lamp.]** appears. If you continue to use the lamp after the lamp has reached the end of its usable life, the lamp bulb may shatter, and pieces of glass may be scattered in the lamp case. Do not touch them as the pieces of glass may cause injury. If this happens, contact your dealer for lamp replacement.



CAUTION

When removing the lamp from a ceiling-mounted projector, make sure that no one is under the projector. Glass fragments could fall if the lamp has been burned out.

NOTE FOR CUSTOMERS IN THE US

 LAMP(S) INSIDE THIS PRODUCT CONTAIN MERCURY AND MUST BE RECYCLED OR DISPOSED OF ACCORDING TO LOCAL, STATE OR FEDERAL LAWS.

For UK only: In UK, a BS approved power cord with moulded plug has a Black (five Amps) fuse installed for use with this equipment. If a power cord is not supplied with this equipment please contact your supplier.

Important Safeguards

These safety instructions are to ensure the long life of your projector and to prevent fire and shock. Please read them carefully and heed all warnings.

Installation

- Do not place the projector in the following conditions:
 - on an unstable cart, stand, or table.
 - near water, baths or damp rooms.
 - in direct sunlight, near heaters or heat radiating appliances.
 - in a dusty, smoky or steamy environment.
 - on a sheet of paper or cloth, rugs or carpets.
- If you wish to have the projector installed on the ceiling:
 - Do not attempt to install the projector yourself.
 - The projector must be installed by qualified technicians in order to ensure proper operation and reduce the risk of bodily injury.
 - In addition, the ceiling must be strong enough to support the projector and the installation must be in accordance with any local building codes.
 - Please consult your dealer for more information.

Do Not Use in the Following Environments

Do not install the projector in a humid or dusty place or a place where there is much oily smoke or cigarette smoke. Optical parts such as a lens and mirror are stained, resulting in poor picture.

Do not use the projector in a place where the temperature becomes very high or low.

Operating temperature: +5°C to +40°C Storage temperature: -10°C to +50°C
(Quiet mode selected automatically at 95°F to 104°F / 35°C to 40°C)

Place the projector in a horizontal position

The tilt angle of the projector should not exceed 10 degrees, nor should the projector be installed in any way other than the desktop and ceiling mount, otherwise lamp life could decrease dramatically.



Fire and Shock Precautions

- Ensure that there is sufficient ventilation and that vents are unobstructed to prevent the build-up of heat inside projector. Allow at least 1 m (3.3') of space between your projector and a wall.
- Prevent foreign objects such as paper clips and bits of paper from falling into your projector. Do not attempt retrieve any objects that might fall into your projector. Do not insert any metal objects such as a wire or screwdriver into your projector. If something should fall into your projector, disconnect it immediately and have the object removed by a qualified service personnel.
- Do not place any objects on top of the projector.
- Do not touch the power plug during a thunderstorm. Doing so can cause electrical shock or fire.
- The projector is designed to operate on power source voltages indicated on the rating label on the projector. Ensure that your power fits this requirement before attempting to use your projector.
- Do not look into the lens while the projector is on. Serious damage to your eyes could result.

- Keep any items such as magnifying glass out of the light path of the projector. The light being projected from the lens is extensive, therefore any kind of abnormal objects that can redirect light coming out of the lens, can cause unpredictable outcome such as fire or injury to the eyes.
- Do not cover the lens with the black lens cover or equivalent while the projector is on. Doing so can lead to melting the cap and possibly burning your hands due to the heat emitted from the light output.
- Do not place any objects, which are easily affected by heat, in front of the projector lens or a projector exhaust. Doing so could lead to the object melting or getting your hands burned from the heat that is emitted from the output and exhaust.
- Handle the power cord carefully. A damaged or frayed power cord can cause electric shock or fire.
 - Do not use any power cords than the supplied one.
 - Do not bend or tug the power cord excessively.
 - Do not place the power cord under the projector, or any heavy object.
 - Do not cover the power cord with other soft materials such as rugs.
 - Do not heat the power cord
 - Do not handle the power plug with wet hands.
- Turn off the projector, unplug the power cord and have the projector serviced by a qualified service personnel under the following conditions:
 - When the power cord or plug is damaged or frayed.
 - If liquid has been spilled into the projector, or if it has been exposed to rain or water.
 - If the projector does not operate normally when you follow the instructions described in this user's manual.
 - If the projector has been dropped or the cabinet has been damaged.
 - If the projector exhibits a distinct change in performance, indicating a need for service.
- Disconnect the power cord and any other cables before carrying the projector
- Turn off the projector and unplug the power cord before cleaning the cabinet or replacing the lamp.
- Turn off the projector and unplug the power cord if the projector is not to be used for an extended period of time.
- When using a LAN cable:
For safety, do not connect to the connector for peripheral device wiring that might have excessive voltage.

CAUTION

- Do not try to touch the ventilation outlet on the left side (when seen from the front) as it can become heated while the projector is turned on.
- Do not use the tilt-foot for purposes other than originally intended. Misuses such as gripping the tilt-foot or hanging on the wall can cause damage to the projector.
- Select [High] in Fan mode if you continue to use the projector for consecutive days. (From the menu, select [Setup]→ [Options (1)] → [Fan mode] → [High].) Fan noise increases noticeably in High mode. See page 63.
- Do not turn off the AC power for 60 seconds after the lamp is turned on and while the POWER indicator is blinking green. Doing so could cause premature lamp failure.
- Do not hold the lens part when carrying the projector.
Doing so could cause the focus ring to rotate, resulting in accidental dropping of the projector.

CARRYING/TRANSPORTING THE PROJECTOR

This projector is a precision machine. Do not give a strong shock to the projector or turn it down. Thoroughly read "Use Caution When Carrying or Transporting the Projector" below and install the lens cover before carrying the projector. When transporting the projector by train or airplane, use a highly crashworthy transport case.

Use Caution When Carrying or Transporting the Projector

The carrying bag is intended for protection from dust and scratches on the surface of the cabinet, and it is not designed to protect the projector from external shocks. When carrying the projector with it put in the carrying bag, do not give a shock to it, drop it, or place anything on it. Do not transport the projector through a courier or transport service with the carrying bag. The projector can damage.



Remote Control Precautions

- Handle the remote control carefully.
- If the remote control gets wet, wipe it dry immediately.
- Avoid excessive heat and humidity.
- Do not heat, take apart, or throw batteries into fire.
- If you will not be using the remote control for a long time, remove the batteries.
- Ensure that you have the batteries' polarity (+/-) aligned correctly.
- Do not use new and old batteries together, or use different types of batteries together.
- Dispose of used batteries according to your local regulations.

About [High altitude] mode

- Set [Fan mode] to [High altitude] when using the projector at altitudes approximately 5500 feet/1600 meters or higher. See page 63.
Using the projector at altitudes approximately 5500 feet/1600 meters or higher without setting to [High altitude] can cause the projector to overheat and the protector could shut down. Furthermore, the projector could not turn on due to the increased temperature of the lamp after power off. If these happen, wait a couple minutes and turn on the projector.
Fan noise increases noticeably in [High altitude]. See page 63.
- Using the projector at altitudes less than approximately 5500 feet/1600 meters and setting to [High altitude] can cause the lamp to overcool, causing the image to flicker. Switch [Fan mode] to [Auto].
- Using the projector at altitudes approximately 5500 feet/1600 meters or higher can shorten the life of optical components such as the lamp.

About Copyright of original projected pictures:

Please note that using this projector for the purpose of commercial gain or the attraction of public attention in a venue such as a coffee shop or hotel and employing compression or expansion of the screen image with the following functions may raise concern about the infringement of copyrights which are protected by copyright law. [Aspect], [Keystone adjustment], Magnifying (D.ZOOM) feature and other similar features.

Table of Contents

Important Information	i
1. Introduction	1
1 What's in the Box?	1
2 Introduction to the Projector	2
Congratulations on Your Purchase of The Projector	2
Features you'll enjoy:	2
About this user's manual	3
Comparative Table of Main Features	3
3 Part Names of the Projector	4
Front/Top	4
Rear	4
Top Features	5
Terminal Panel Features	6
4 Part Names of the Remote Control	7
Battery Installation	9
Remote Control Precautions	9
Operating Range for Wireless Remote Control	9
2. Installation and Connections	10
1 Setting Up the Screen and the Projector	11
Selecting a Location (LV-7385/LV-7380/LV-7285/LV-7280)	11
Throw Distance and Screen Size	11
Selecting a Location (LV-8310/LV-8215)	12
Throw Distance and Screen Size	12
2 Making Connections	14
Enabling the computer's external display	14
Connecting Your PC or Macintosh Computer	14
When Viewing a DVI Digital Signal	16
Connecting an External Monitor	18
Connecting Your Audio-Video Equipment with Component Output	19
Connecting Your Audio-Video Equipment with Video/S-Video Output	20
Connecting a Digital Video Signal	21
Connecting to a Network	22
Connecting the Supplied Power Cord	23
3. Projecting an Image (Basic Operation)	24
1 Turning on the Projector	24
2 Selecting a Source	26
3 Adjusting the Picture Size and Position	28
4 Correcting Keystone Distortion	31
5 Automatically Optimizing on RGB Image	34
6 Turning Up or Down Volume	34
7 Turning off the Projector	35
8 After Use	36

4. Convenient Features	37
① Turning off the Image and Sound	37
② Freezing a Picture	37
③ Enlarging a Picture	37
④ Lamp Mode and Energy-Saving Effect	38
⑤ Preventing the Unauthorized Use of the Projector [Password]	40
⑥ Network and Alert Mail Settings by Using an HTTP Browser	43
5. Using On-Screen Menu	47
① Using the Menus	47
② Menu Elements	48
③ List of Menu Items	49
④ Menu Descriptions & Functions [Input]	51
⑤ Menu Descriptions & Functions [Adjustment]	52
⑥ Menu Descriptions & Functions [Setup]	59
⑦ Menu Descriptions & Functions [Information]	66
⑧ Menu Descriptions & Functions [Reset]	68
6. Maintenance	69
① Cleaning or Replacing the Filter	69
② Cleaning the Cabinet and the Lens	70
③ Replacing the Lamp	71
7. Appendix	74
① Troubleshooting	74
② Specifications	77
③ Cabinet Dimensions	79
④ Pin Assignments of D-Sub ANALOG IN-1 Input Connector	80
⑤ Compatible Input Signal List	81
⑥ Relationship between Screen Size and Projection distance	82
⑦ PC Control Codes and Cable Connection	84
⑧ Troubleshooting Check List	85

1. Introduction

① What's in the Box?

Make sure your box contains everything listed. If any pieces are missing, contact your dealer. Please save the original box and packing materials if you ever need to ship your projector.

Projector

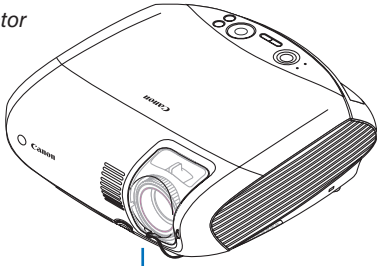

Lens cover

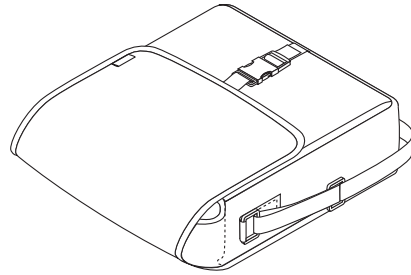

Soft case

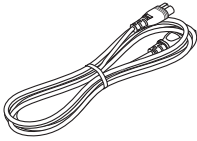

AC power cord

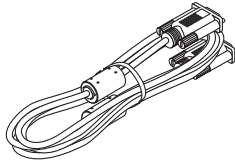

VGA cable
[7N520077]

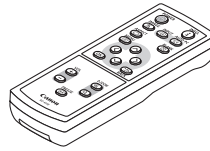

Remote control

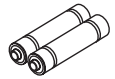

Batteries (AAA×2)

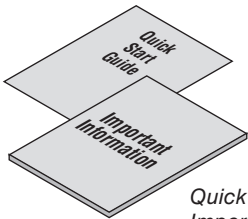

Quick Start Guide
Important Information

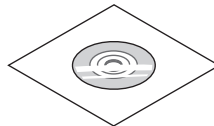

CD-ROM
User's manual

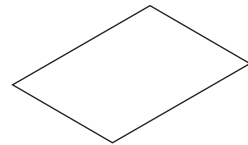

Warranty

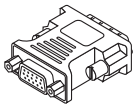

DVI to VGA adapter

② Introduction to the Projector

This section introduces you to your new projector and describes the features and controls.

Congratulations on Your Purchase of The Projector

The LV-7385/LV-7380/LV-7285/LV-7280/LV-8310/LV-8215 is one of the very best projectors available today. The projector enables you to project precise images up to 300 inches across (measured diagonally) from your PC or Macintosh computer (desktop or notebook), or audio-video equipment.

You can use the projector on a tabletop or cart, from behind a screen, or permanently mounted on a ceiling^{*1}. The remote control can be used wirelessly.

^{*1} Do not attempt to mount the projector on a ceiling yourself.

The projector must be installed by qualified technicians in order to ensure proper operation and reduce the risk of bodily injury.

In addition, the ceiling must be strong enough to support the projector and the installation must be in accordance with any local building codes. Please consult your dealer for more information.

Features you'll enjoy:

- Quick Start, Quick Power Off, Direct Power Off
Less than 4 seconds* after turning on the power, the projector is ready to display PC or video images. The projector can be put away immediately after the projector is powered down. No cool down period is required after the projector is turned off from the remote control or cabinet control panel.
* The quick start time is only when [Standby mode] is set to [Normal] in the on-screen message.
The projector has a feature called "Direct Power Off". This feature allows the projector to be turned off (even when projecting an image). See page 35.
- Carbon Meter
This feature will show energy-saving effect in terms of CO₂ emission reduction (kg) when the projector's [Lamp mode] is set to [Quiet mode]. The amount of CO₂ emission reduction will be displayed in the confirmation message at the time of power-off and in the Information of the on-screen menu.
- Less than 1W in standby condition with energy saving technology
Selecting [Power-saving] for [Standby mode] from the menu can put the projector in power-saving mode that consumes less than 1W.
- Long-life Lamp employed
The Long-life lamp provides 4000 hours of use at the [Normal] for Lamp mode and 5000 hours of use at the [Quiet] for Lamp mode.
- Direct power on and Power Management features
The Direct power on (AC), Direct power on (Comp1), Power management, and Off timer features eliminate the need to always use the POWER button on the remote control or projector cabinet.
(For Direct power on (AC), Direct power on (Comp1), and Power management, see page 65; for Off timer, see page 64.)
- A variety of input ports and a comprehensive array of system control interfaces
This projector supports input signals on the following ports: DVI-I connector (DVI-I 29 Pin) with HDCP compatible, 15pin D-Sub, composite and S-video.
- 7W built-in speaker for an integrated audio solution
Powerful 7 watt speaker provides volume need for large rooms.
- Auto vertical keystone correction
Auto Keystone feature allows the projector to detect its tilt and correct vertical distortion automatically. (page 31)
- Supporting up to UXGA resolution
High resolution display - up to UXGA compatible, XGA (LV-7385/LV-7380/LV-7285/LV-7280)/ WXGA (LV-8310/LV-8215) native resolution.
- Five picture preset modes for user adjustable picture and color settings
Each picture preset mode can be customized and memorized according to your preference. (page 52)
- Preventing unauthorized use of the projector
Enhanced smart security settings for password protection (page 40), cabinet key lock (page 62), and anti-theft

- security cable lock (page 4) to help prevent unauthorized access, adjustments and theft deterrence.
- Notifying an error message via e-mail when using wired LAN
 The Alert Mail feature notifies your computer of an error message via e-mail when using wired LAN. The error message will be notified when the projector lamp has reached the end of its usable life or an error occurs in the projector (page 45). You can configure the network settings of the projector on your computer. (page 43)

About this user's manual

The fastest way to get started is to take your time and do everything right the first time. Take a few minutes now to review the user's manual. This may save you time later on. At the beginning of each section of the manual you'll find an overview. If the section doesn't apply, you can skip it.

- IBM is a trademark or registered trademark of International Business Machines Corporation.
- Macintosh, Mac OS X and PowerBook are trademarks of Apple Inc. registered in the U.S. and other countries.
- Microsoft, Windows, and Internet Explorer are either registered trademarks or trademarks of Microsoft Corporation in the United States and/or other countries.
- MicroSaver is a registered trademark of Kensington Computer Products Group, a division of ACCO Brands.
- Other product and company names mentioned in this user's manual may be the trademarks or registered trademarks of their respective holders.

Comparative Table of Main Features

The main features vary depending on the model name as follows.

	Standard Models				Wide Panel Models	
	LV-7385	LV-7380	LV-7285	LV-7280	LV-8310	LV-8215
Native Aspect Ratio (→ page 77)	4 : 3 Standard				16 : 10 Wide	
Native Resolution (dots x lines) (→ page 77)	XGA (1024 x 768)				WXGA (1280 x 800)	
Screen Size (Mini. to Max) (→ page 77)	21" - 300"					
Throw Distance (→ page 77)	0.8 m to 11.3 m/31.5" to 444.9"				0.8m to 11.95m/31.5" to 470.5"	
Light output in [Normal] for [Lamp mode] (→ page 77)	3500 lumens	3000 lumens	2600 lumens	2200 lumens	3000 lumens	2600 lumens
Contrast Ratio (→ page 77)	500: 1		2000: 1*		500: 1	450: 1
Wired LAN (→ page 22, 43)	RJ-45					
Lamp Replacement Time (average) (→ page 66)	4000 (H) in [Normal] mode /5000 (H) in [Quiet] mode					
Replacement Lamp (→ page 71)	LV-LP31	LV-LP32			LV-LP31	

* The value is measured when [Auto iris] is set to [On].

For further details on the specifications, see page 77.

TIP: The model name is located on the cabinet.

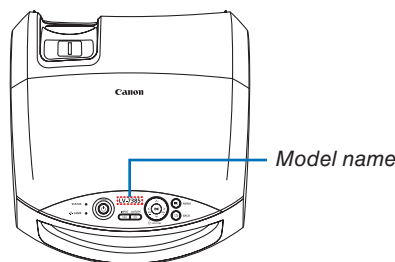

3 Part Names of the Projector

Front/Top

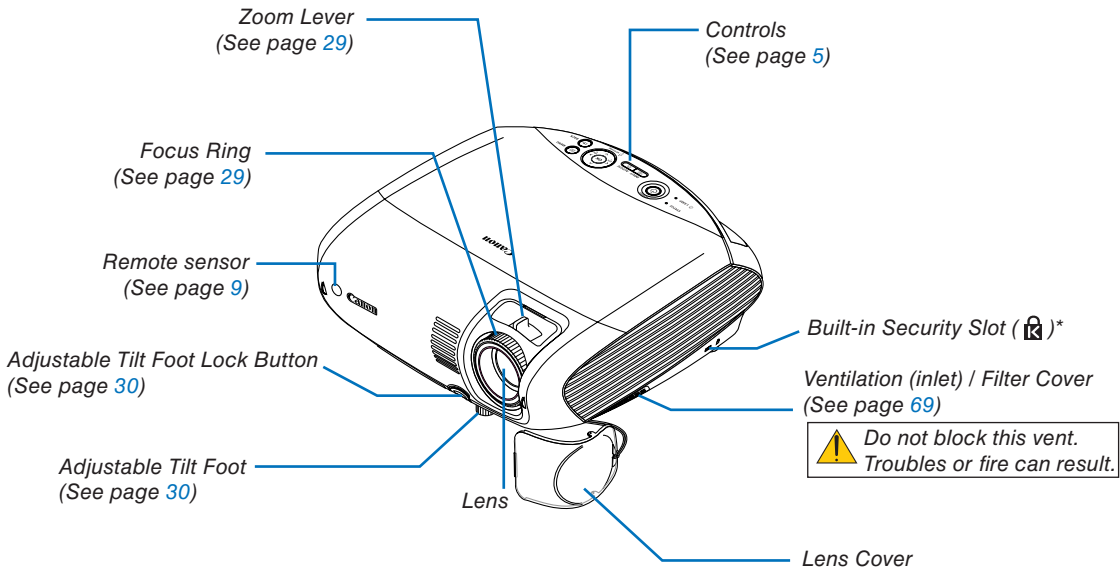

⚠ Do not block this vent. Troubles or fire can result.

⚠ Be sure to remove the lens cover during projection. The cap can deform or fire can occur.

* This security slot supports the MicroSaver® Security System.

Rear

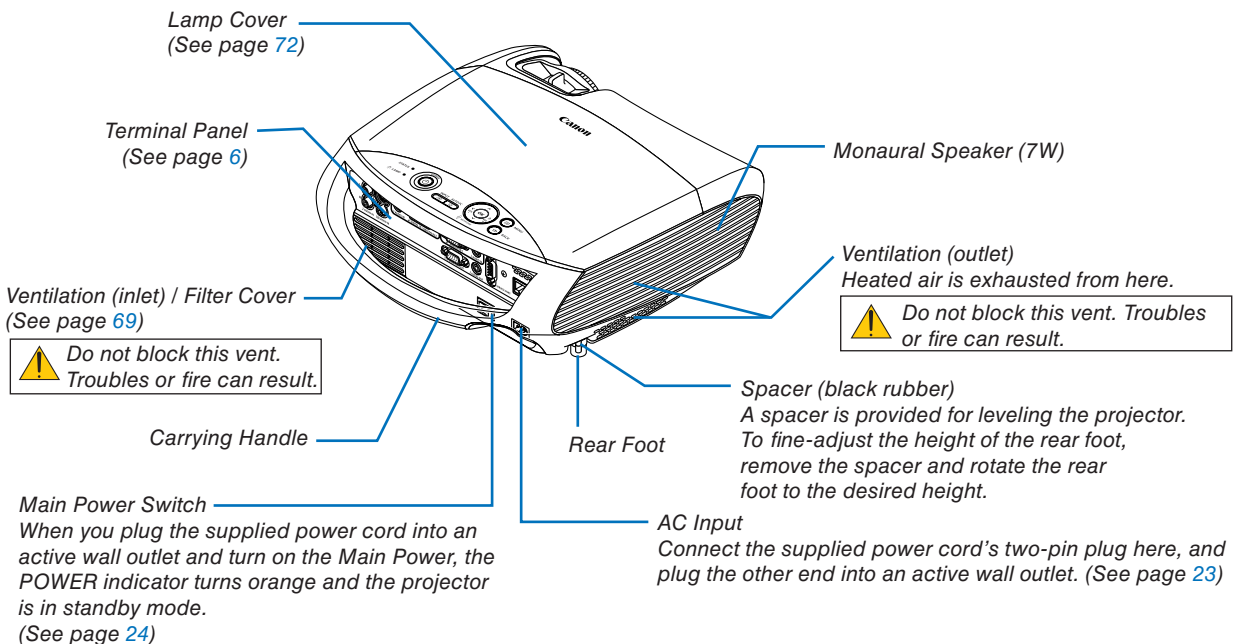

⚠ Do not block this vent. Troubles or fire can result.

⚠ Do not block this vent. Troubles or fire can result.

Top Features

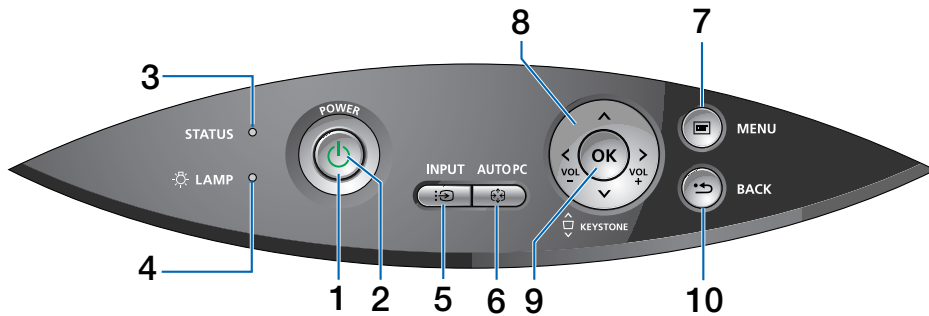

1. POWER Button ()

Use this button to turn the power on and off when the main power is supplied and the projector is in standby mode.

To turn on the projector, press and hold this button for about 1 second. To turn off the projector, press this button twice.

2. POWER Indicator

When this indicator is green, the projector is on, when the projector is turned off (standby mode), this indicator lights orange when [Normal] is selected for [Standby mode]; it lights red when [Power-saving] is selected for [Standby mode]. See the POWER Indicator section on page 74 for more details.

3. STATUS Indicator

If this light blinks red rapidly, it indicates that an error has occurred, the lamp cover is not attached properly or the projector has overheated. If this light remains orange, it indicates that you have pressed a cabinet key while the Key lock is enabled. See the STATUS Indicator section on page 74 for more details.

4. LAMP Indicator

If this light blinks red rapidly, it's warning you that the lamp has reached the end of its usable life. After this light appears, replace the lamp as soon as possible (See page 71). If this is lit green continually, it indicates that the lamp mode is set to Quiet. See the LAMP Indicator section on page 74 for more details.

This indicator lights green for about 90 seconds immediately after the projector is powered on.

5. INPUT Button

Selecting from INPUT List

Press and quickly release the INPUT button to display the INPUT list. Each time the INPUT button is pressed, the input source will change.

To display the selected source, press the OK button or allow 2 seconds to elapse.

Detecting the Signal Automatically

Press and hold the INPUT button for a minimum of 2 seconds, the projector will search for the next available input source. See page 26.

6. AUTO PC Button

Use this button to adjust an analog RGB source for an optimal picture. See page 34.

7. MENU Button

Displays the menu. See page 47.

8. ◀▶ / VOL (+/-) / KEYSTONE (⌵⌶) Buttons

◀▶ : Use these buttons to select the menu of the item you wish to adjust. See page 47.

When no menus appear, these buttons work as a keystone control. See page 32.

◀▶ : Use these buttons to change the level of a selected menu item. A press of the ▶ button executes the selection. When no menus appear, these buttons work as a volume control. See page 34.

9. OK Button

Executes your menu selection and activates items selected from the menu.

10. BACK Button

Pressing this button will return to the previous menu.

While you are in the main menu, pressing this button will close the menu.

Terminal Panel Features

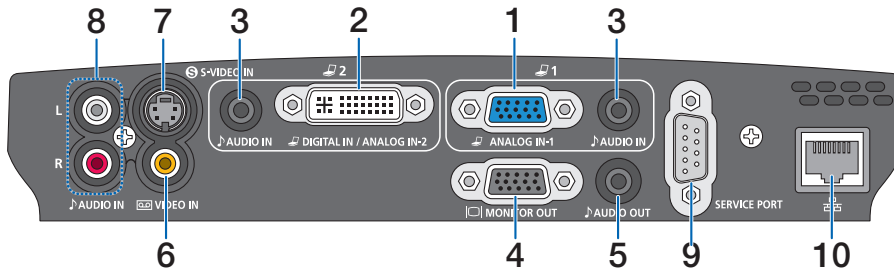

1. Computer 1 Input Connector [ANALOG IN-1] (Mini D-Sub 15 Pin)

Connect your computer or other analog RGB equipment such as IBM compatible or Macintosh computers. Use the supplied VGA cable to connect to your computer. This also serves as a component video input connector that allows you to connect a component video output of audio-video equipment. See page 14, 17, 19.

Note that this cannot be used as a headphone jack. (When audio equipment is connected, the projector speaker is disabled.)

When a cable mini-plug is inserted into this jack, both the right and left audio signals are not mixed, but separate. For example, when a cable mini-plug is inserted into the left AUDIO IN jack only, only left sound is output.

2. Computer 2 Input Connector [DIGITAL IN/ANALOG IN-2] (DVI-I 29 Pin)

Connect the DVI output of your computer or other digital RGB equipment such as IBM compatible or Macintosh computers. You can also use the supplied DVI to VGA adapter to connect the output of analog RGB equipment. See page 16, 17, 21.

6. VIDEO IN Connector (RCA)

Connect audio-video equipment here to project video. See page 20.

7. S-VIDEO IN Connector (Mini DIN 4 Pin)

Here is where you connect the S-Video input from audio-video equipment. See page 20.

NOTE: S-Video provides more vivid color and higher resolution than the traditional composite video format.

3. AUDIO IN Mini Jack (Stereo Mini)

This is where you connect the audio output from your computer or audio-video equipment when connected to the ANALOG IN-1 or 2 input. A commercially available audio cable is required. See page 14, 16, 18, 19, 21.

8. AUDIO IN Jacks L/R (RCA)

These are your left and right channel audio inputs for stereo sound from a Video/S-Video source. See page 20, 21.

4. MONITOR OUT Connector [] (Mini D-Sub 15 Pin)

You can use this connector to loop your computer image to an external monitor from the RGB input source (ANALOG IN-1). This connector outputs RGB signal in standby mode. See page 18.

9. SERVICE PORT (D-Sub 9 Pin)

Use this port to connect a computer or control system. This enables you to control the projector using serial communication protocol. If you are writing your own program, typical PC control codes are on page 84.

5. AUDIO OUT Mini Jack (Stereo Mini)

You can use this jack to output sound to your audio-video equipment from the currently selected source. Output sound level can be adjusted in accordance with the sound level of the internal speaker.

10. LAN Port [] (RJ-45)

Use this port when controlling your projector in LAN connection from a computer. Use a commercially available LAN cable (10 Base-T/100 Base-T) to connect the projector to the computer. See page 22.

4 Part Names of the Remote Control

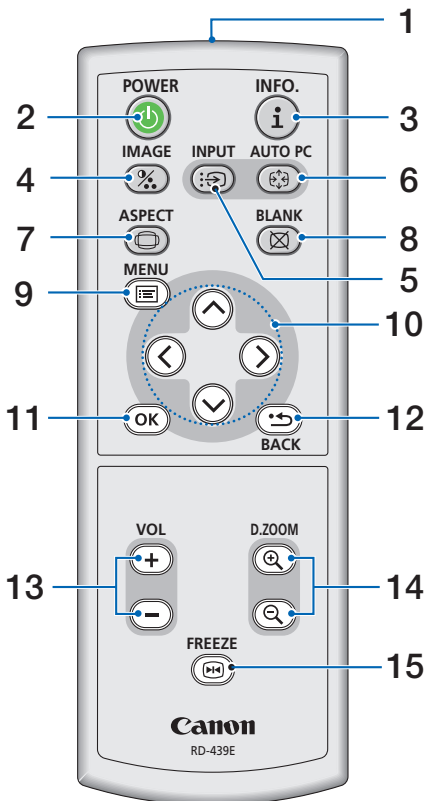

1. Infrared Transmitter

Direct the remote control toward the remote sensor on the projector cabinet.

2. POWER Button

When the main power is on, you can use this button to turn your projector on.

NOTE: To turn on the projector, press and hold the POWER button for about 1 second.

You can use this button to turn your projector off.

NOTE: To turn off the projector, press this button twice.

3. INFO. Button

Provides the information on the current signal and projector settings. See page 66.

4. IMAGE Button

Press this button to display the Image adjustment menu to adjust Image mode, Contrast, Brightness, Sharpness, Color level and Color balance. See pages 52 to 53.

5. INPUT Button

Selecting from INPUT List

Press and quickly release the INPUT button to display the INPUT list. Each time the INPUT button is pressed, the input source will change.

Detecting the Signal Automatically

Press and hold the INPUT button for a minimum of 2 seconds, the projector will search for the next available input source.

See page 26.

6. AUTO PC Button

Use this button to adjust an analog RGB source for an optimal picture. See page 34.

7. ASPECT Button

Press this button once to display the Aspect select menu. Keep pressing will change aspect ratios. See page 56.

8. BLANK Button

This button turns off the image and sound for a short period of time. Press again to restore the image and sound. See page 37.

9. MENU Button

Displays the menu for various settings and adjustments. See page 47.

10. ⏪⏩⏴⏵ Button

See page 47.

⏪⏩: Use these buttons to select the menu of the item you wish to adjust.

⏴⏵: Use these buttons to change the level of a selected menu item. A press of the ⏴ button executes the selection.

When an image is magnified, the ⏪⏩⏴⏵ button moves the image. See page 37.

11. OK Button

Use this button to enter your menu selection. It works the same way as the OK button on the cabinet. See page 5.

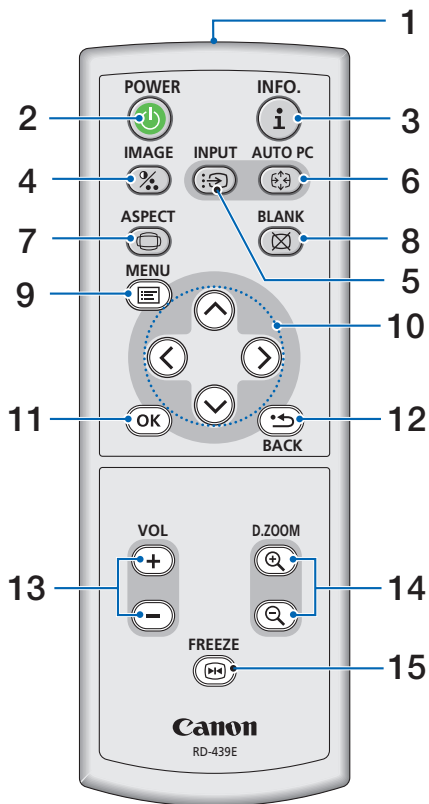

12. BACK Button

It works the same way as the BACK button on the cabinet. See page 5.

13. VOL (+) (-) Button

Press (+) to increase the volume and (-) to decrease it. See page 34.

14. D. ZOOM (+) (-) Button

Use this button to adjust the image size up to 400%.

The image is magnified about the center of the screen. See page 37.

15. FREEZE Button

This button will freeze a picture. Press again to resume motion. See page 37.

Battery Installation

- 1 Press firmly and slide the battery cover off.

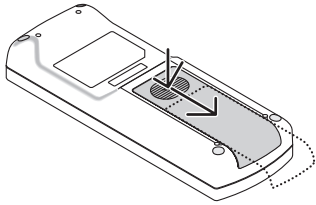

- 2 Remove both old batteries and install new ones (AAA). Ensure that you have the batteries' polarity (+/-) aligned correctly.

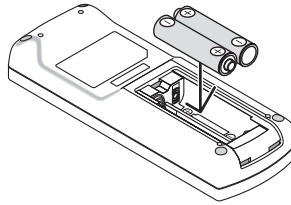

- 3 Slip the cover back over the batteries until it snaps into place. Do not mix different types of batteries or new and old batteries.

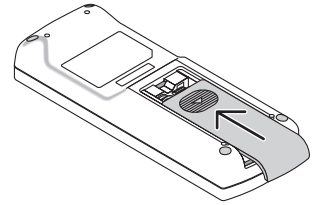

Remote Control Precautions

- Handle the remote control carefully.
- If the remote control gets wet, wipe it dry immediately.
- Avoid excessive heat and humidity.
- Do not heat, take apart, or throw batteries into fire.
- Ensure that you have the batteries' polarity (+/-) aligned correctly.
- If you will not be using the remote control for a long time, remove the batteries.
- Do not place the batteries upside down.
- Do not use new and old batteries together, or use different types of batteries together.
- Dispose of used batteries according to your local regulations.

Operating Range for Wireless Remote Control

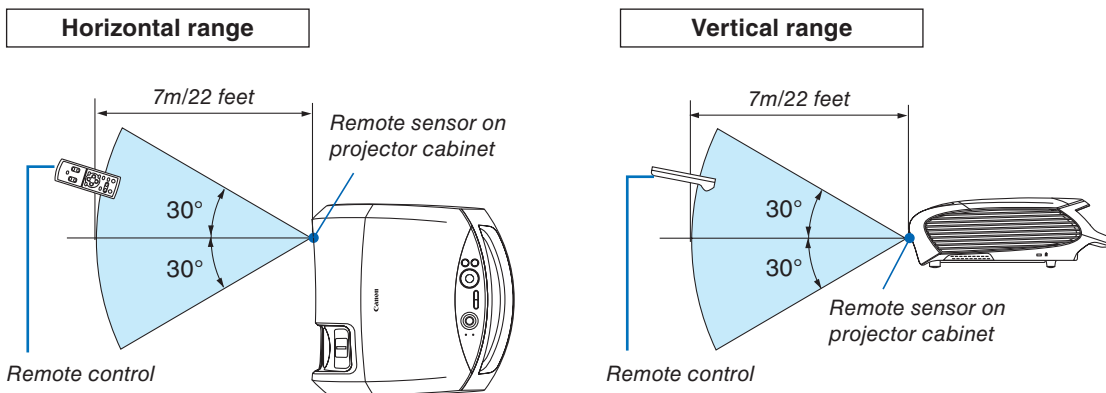

- The infrared signal operates by line-of-sight up to a distance of about 7 m (22 feet) and within a 60-degree angle of the remote sensor on the projector cabinet.
- The projector will not respond if there are objects between the remote control and the sensor, or if strong light falls on the sensor. Weak batteries will also prevent the remote control from properly operating the projector.

2. Installation and Connections

This section describes how to set up your projector and how to connect video and audio sources.

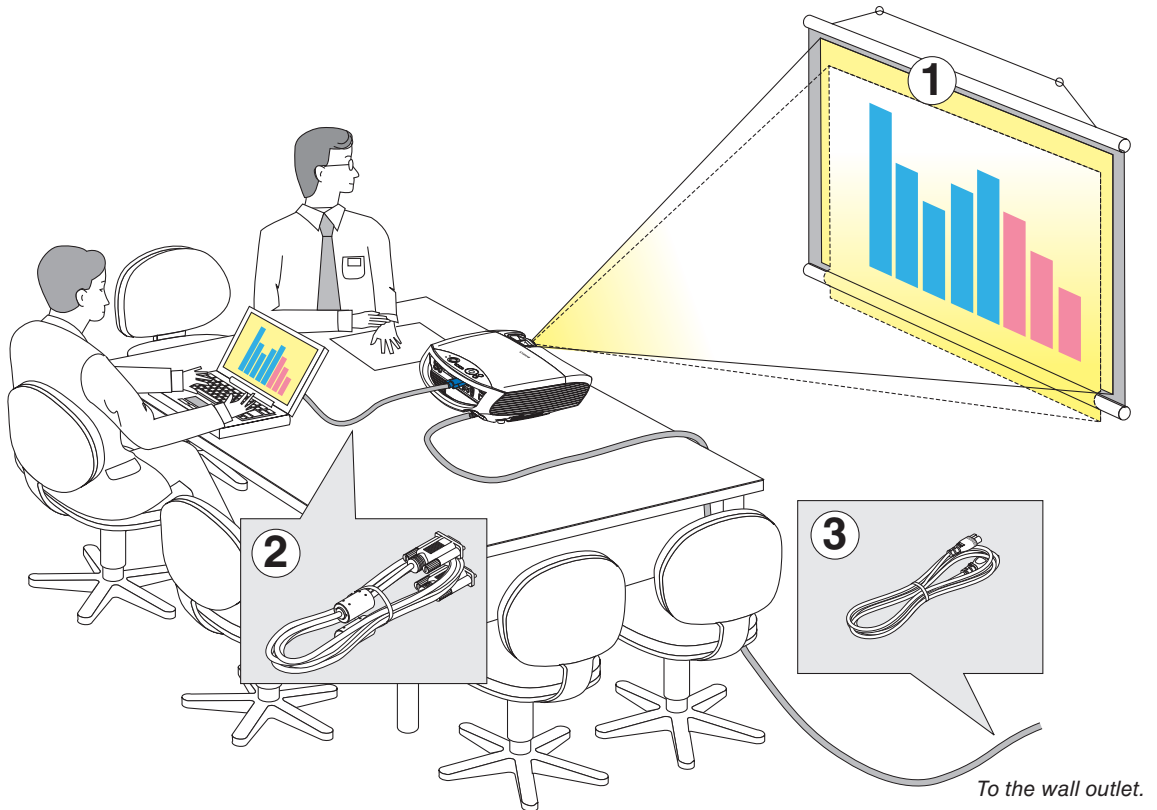

Your projector is simple to set up and use. But before you get started, you must first:

- ① Set up a screen and the projector. See page [11](#), [12](#).
- ② Connect your computer or audio-video equipment to the projector. See pages [14](#), [16](#), [17](#), [18](#), [19](#), [20](#), [21](#), [22](#).
- ③ Connect the supplied power cord. See page [23](#).

NOTE: Ensure that the power cord and any other cables are disconnected before moving the projector. When moving the projector or when it is not in use, cover the lens with the lens cover.

1 Setting Up the Screen and the Projector

Selecting a Location (LV-7385/LV-7380/LV-7285/LV-7280)

The further your projector is from the screen or wall, the larger the image. The minimum size the image can be is approximately 21" measured diagonally when the projector is roughly 0.8 m (2.6') from the wall or screen. The largest the image can be is 300" when the projector is about 11.3 m (37.0') from the wall or screen. Use the drawing below as a guide.

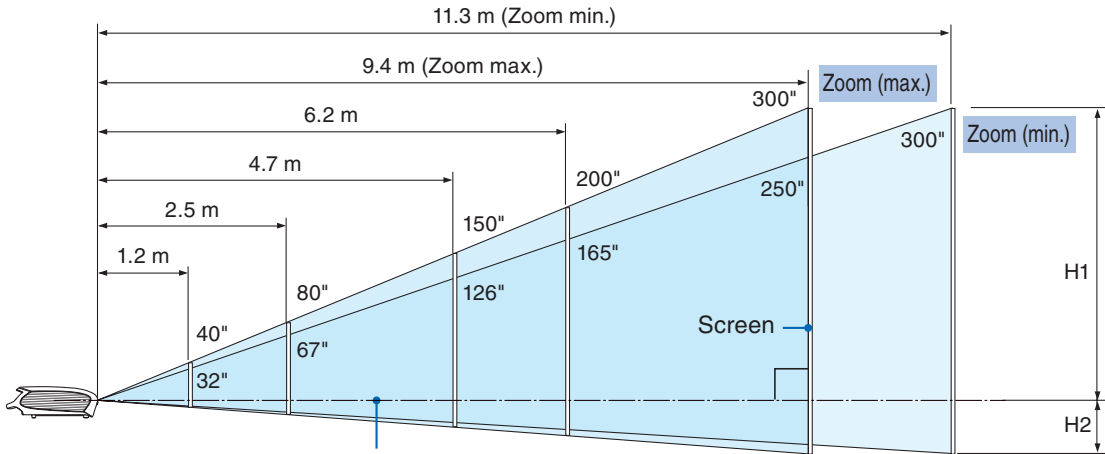

Optional axis when image is projected at right angle to the screen.

Throw Distance and Screen Size

Screen size (W×H) cm	21"	25"	30"	40"	60"	80"	100"	150"	180"	200"	250"	300"
Projection distance Zoom (max)	–	0.8 m (2.6')	0.9 m (3.0')	1.2 m (3.9')	1.9 m (6.2')	2.5 m (8.2')	3.1 m (10.2')	4.7 m (15.4')	5.6 m (18.4')	6.2 m (20.3')	7.8 m (25.6')	9.4 m (30.8')
Projection distance Zoom (min)	0.8 m (2.6')	0.9 m (3.0')	1.1 m (3.6')	1.5 m (4.9')	2.2 m (7.2')	3.0 m (9.8')	3.7 m (12.1')	5.6 m (18.4')	6.8 m (22.3')	7.5 m (24.6')	9.4 m (30.8')	11.3 m (37.1')
H1	27 cm (0.9')	32 cm (1.1')	39 cm (1.3')	51 cm (1.7')	77 cm (2.5')	103 cm (3.4')	129 cm (4.2')	193 cm (6.3')	231 cm (7.6')	257 cm (8.4')	321 cm (10.5')	386 cm (12.7')
H2	5 cm (0.2')	6 cm (0.2')	7 cm (0.2')	10 cm (0.3')	14 cm (0.5')	19 cm (0.6')	24 cm (0.8')	36 cm (1.2')	43 cm (1.4')	48 cm (1.6')	60 cm (2.0')	71 cm (2.3')

H1 and H2: H1 is the height of the screen from the intersection of optical axis and screen surface, and H2 is the height of the intersection when an image is projected at right angle to the screen.

- The sizes in the above table have been obtained assuming that the aspect ratio is 4:3. They may vary from the actual sizes depending on the type of the projected image.

Selecting a Location (LV-8310/LV-8215)

The further your projector is from the screen or wall, the larger the image. The minimum size the image can be is approximately 21" measured diagonally when the projector is roughly 0.8 m (2.6') from the wall or screen. The largest the image can be is 300" when the projector is about 12.0 m (39.0') from the wall or screen. Use the drawing below as a guide.

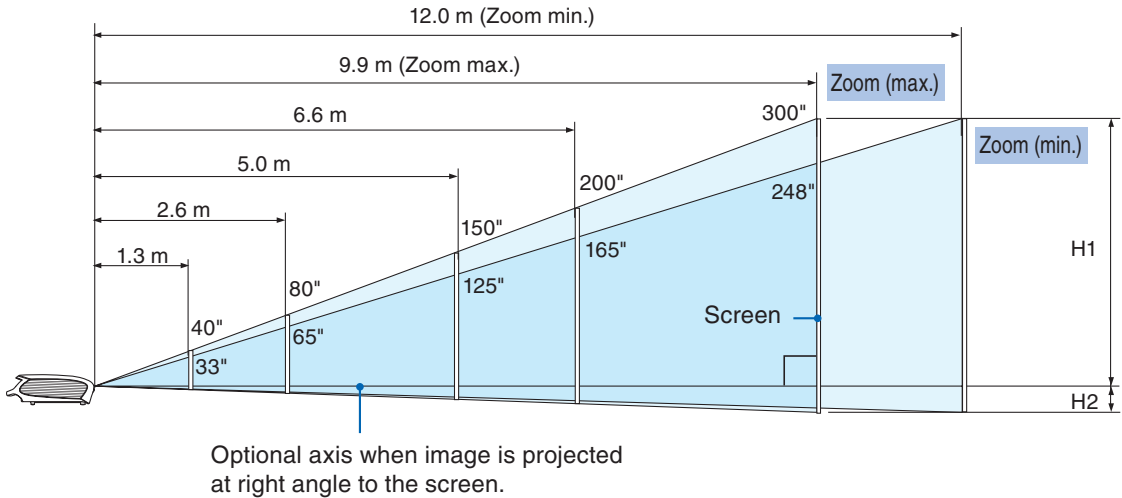

Throw Distance and Screen Size

Screen size (W x H cm)	21" 45 x 28	25" 54 x 34	30" 65 x 40	40" 86 x 54	60" 129 x 81	80" 172 x 108	100" 215 x 135	150" 323 x 202	180" 388 x 242	200" 431 x 269	250" 538 x 337	300" 646 x 404
Projection distance Zoom (max)	-	0.8 m (2.6')	1.0 m (3.2')	1.3 m (4.2')	2.0 m (6.4')	2.6 m (8.6')	3.3 m (10.8')	5.0 m (16.3')	6.0 m (19.5')	6.6 m (21.7')	8.3 m (27.2')	9.9 m (32.6')
Projection distance Zoom (min)	0.8 m (2.6')	1.0 m (3.2')	1.2 m (3.8')	1.6 m (5.1')	2.4 m (7.7')	3.2 m (10.4')	4.0 m (13.0')	6.0 m (19.5')	7.2 m (23.5')	8.0 m (26.1')	10.0 m (32.7')	12.0 m (39.2')
H1	26 cm (0.8')	31 cm (1.0')	37 cm (1.2')	49 cm (1.6')	74 cm (2.4')	98 cm (3.2')	123 cm (4.0')	184 cm (6.0')	221 cm (7.3')	246 cm (8.1')	307 cm (10.1')	369 cm (12.1')
H2	2 cm (0.1')	3 cm (0.1')	4 cm (0.1')	5 cm (0.2')	7 cm (0.2')	9 cm (0.3')	12 cm (0.4')	18 cm (0.6')	21 cm (0.7')	24 cm (0.8')	29 cm (1.0')	35 cm (1.2')

H1 and H2: H1 is the height of the screen from the intersection of optical axis and screen surface, and H2 is the height of the intersection when an image is projected at right angle to the screen.

TIP:

- For the relationship between the screen size and projection distance, see the table on page 82, 83.
- The sizes in the above table have been obtained assuming that the aspect ratio is 16:9. They may vary from the actual sizes depending on the type of the projected image.

NOTE:

- The Zoom lever adjusts the image size (diagonal) +/- 10%.
This projector can be hung from the ceiling (Ceiling mounted) with it turned up side down.
When a translucent screen is used, the projector can project an image from behind the screen (Rear).
When the projector is hung from the ceiling or projector projects an image from behind the screen, the image must be inverted vertically or horizontally. See page 62.
 - *When hanging the projector from the ceiling, optional brackets (part No. LV-CL15) are required.*
-

WARNING

- Installing your projector on the ceiling must be done by a qualified technician. Contact your dealer for more information.
- Do not attempt to install the projector yourself.
- Only use your projector on a solid, level surface. If the projector falls to the ground, you can be injured and the projector severely damaged.
- Do not use the projector where temperatures vary greatly. The projector must be used at temperatures between 41°F (5°C) and 104°F (40°C). (Quiet mode selected automatically at 95°F to 104°F/35°C to 40°C).
- Do not expose the projector to moisture, dust, or smoke. This will harm the screen image.
- Ensure that you have adequate ventilation around your projector so heat can dissipate. Do not cover the vents on the side or the front of the projector.

Reflecting the Image

Using a mirror to reflect your projector's image enables you to enjoy a much larger image. Contact your dealer if you need a mirror system. If you're using a mirror system and your image is inverted, use the MENU and  buttons on your projector cabinet or your remote control to correct the orientation. See page 62.

② Making Connections

NOTE: When using with a notebook PC, be sure to connect the projector and notebook PC while the projector is in standby mode and before turning on the power to the notebook PC.

In most cases the output signal from the notebook PC is not turned on unless connected to the projector before being powered up.

** If the screen goes blank while using your remote control, it may be the result of the computer's screen-saver or power management software.*

Enabling the computer's external display

Displaying an image on the notebook PC's screen does not necessarily mean it outputs a signal to the projector. When using a PC compatible laptop, a combination of function keys will enable/disable the external display. Usually, the combination of the 'Fn' key along with one of the 12 function keys gets the external display to come on or off. For more details, refer to your computer's owner's manual.

Connecting Your PC or Macintosh Computer

NOTE: The ANALOG IN-1 and DIGITAL IN/ANALOG IN-2 connectors are supported by Plug & Play.

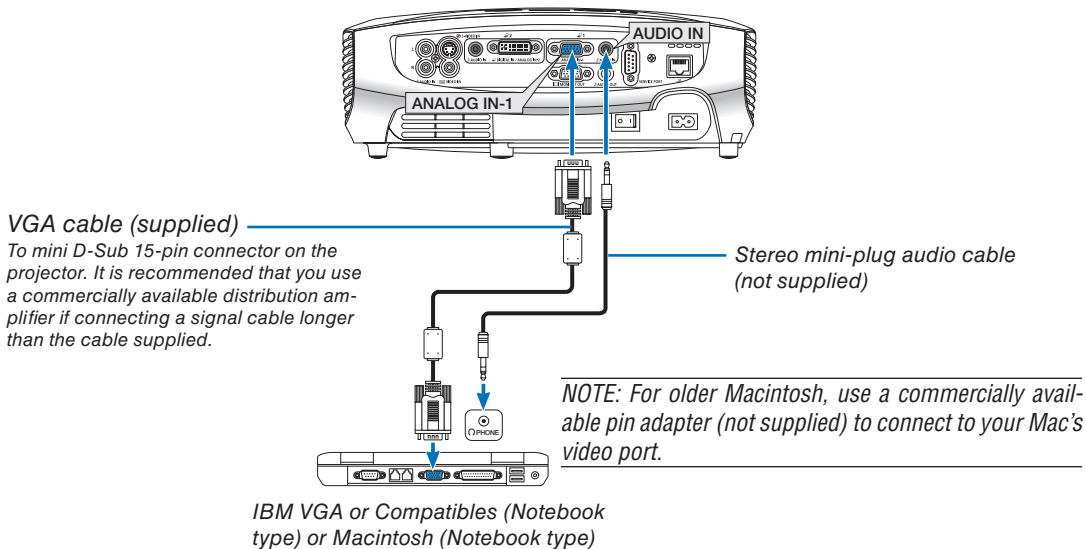

- Select the input name for its appropriate input connector after turning on the projector.

Input connector	Use the INPUT button on the projector cabinet or the remote control to select the appropriate input from the menu.
ANALOG IN-1	 Computer 1

2. Installation and Connections

NOTE: Use an audio cable without a built-in resistor. Using an audio cable with a built-in resistor turns down the sound.

NOTE: An image may not be displayed correctly when a Video or S-Video source is played back via a commercially available scan converter.

This is because the projector will process a video signal as a computer signal at the default setting. In that case, do the following.

** When an image is displayed with the lower and upper black portion of the screen or a dark image is not displayed correctly:
Project an image to fill the screen and then press the AUTO PC button on the remote control or the projector cabinet.*

When Viewing a DVI Digital Signal

To project a DVI digital signal, be sure to connect the PC and the projector using a DVI cable (not supplied) before turning on your PC or projector. Turn on the projector first and select Computer 2 (Digital) from the source menu before turning on your PC.

Failure to do so may not activate the digital output of the graphics card resulting in no picture being displayed. Should this happen, restart your PC.

Do not disconnect the DVI cable while the projector is running. If the signal cable has been disconnected and then re-connected, an image may not be correctly displayed. Should this happen, restart your PC.

NOTE:

- Use a DVI cable or the one compliant with the DDWG (Digital Display Working Group) DVI (Digital Visual Interface) revision 1.0 standard. The DVI cable should be within 5 m (196) long. Both single and dual types of DVI cable can be used.
- The DVI (DIGITAL) connector accepts VGA (640x480), SVGA (800x600), 1152x864, XGA (1024x768), WXGA (1280x800 @ up to 60Hz), and SXGA (1280x1024 @ up to 60Hz).

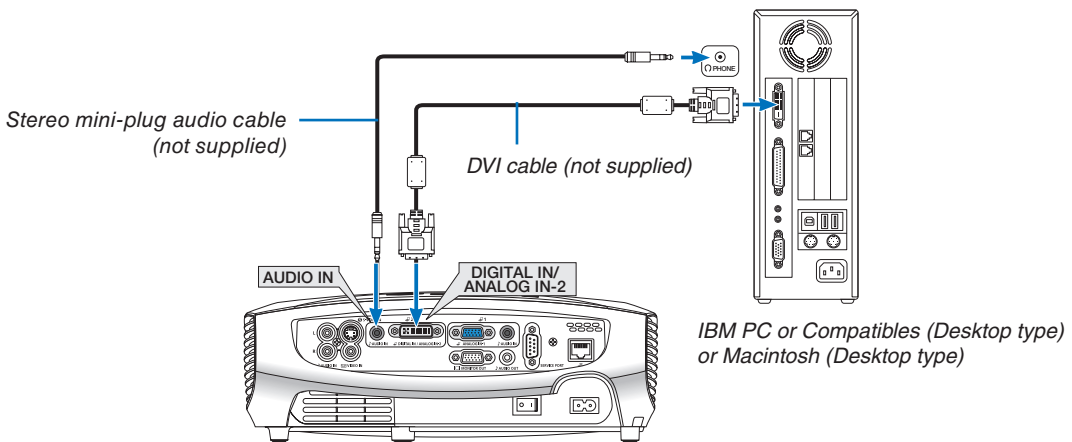

- Select the input name for its appropriate input connector after turning on the projector.

Input connector	Use the INPUT button on the projector cabinet or the remote control to select the appropriate input from the menu.
DIGITAL IN / ANALOG IN-2	 Computer 2 (Digital)

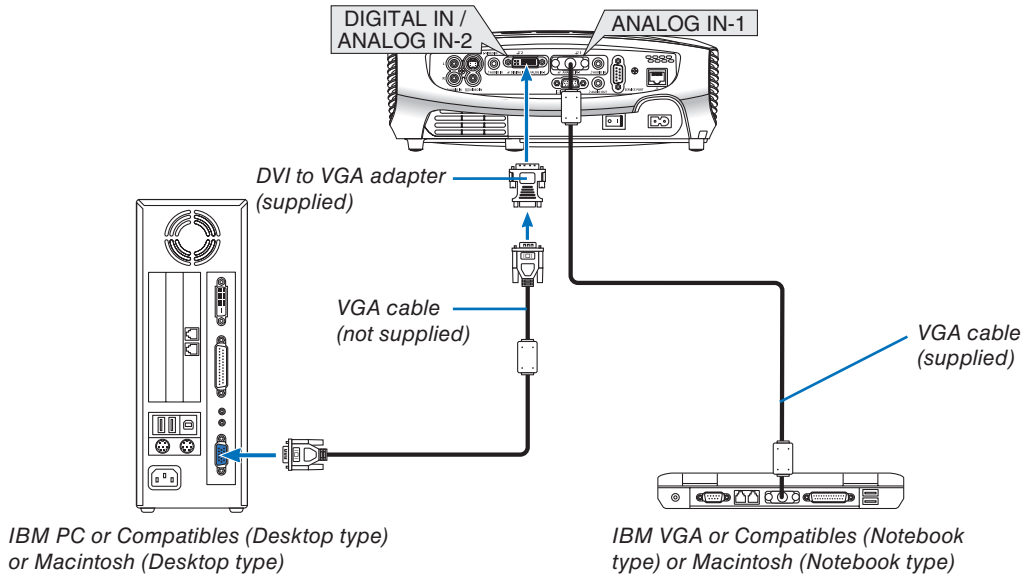

Using Two Analog Computer Inputs Simultaneously

If you need to use two analog inputs simultaneously, connect a VGA cable as shown below.



NOTE: When the DVI to VGA adapter is not to be used for an extended period of time, remove it from the projector. Failure to do so may cause damage to the connector of the projector.

- Select the input name for its appropriate input connector after turning on the projector.

Input connector	Use the INPUT button on the projector cabinet or the remote control to select the appropriate input from the menu.
ANALOG IN-1	 Computer 1
DIGITAL IN / ANALOG IN-2	 Computer 2 (Analog)

Connecting an External Monitor

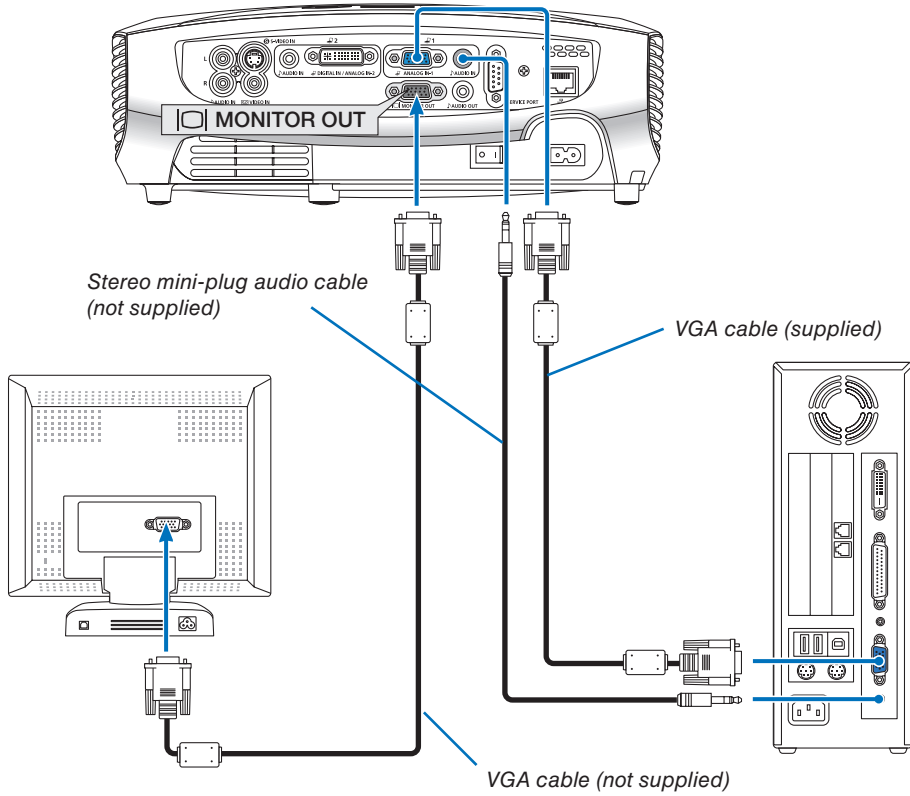

You can connect a separate, external monitor to your projector to simultaneously view on a monitor the RGB analog image you're projecting.

NOTE: Daisy chain connection is not possible.

NOTE:

- The signal from the DIGITAL IN/ANALOG IN-2 connector cannot be output from the MONITOR OUT connector.
 - When audio equipment is connected, the projector speaker is disabled.
 - Use an audio cable without a built-in resistor. Using an audio cable with a built-in resistor turns down the sound.
-

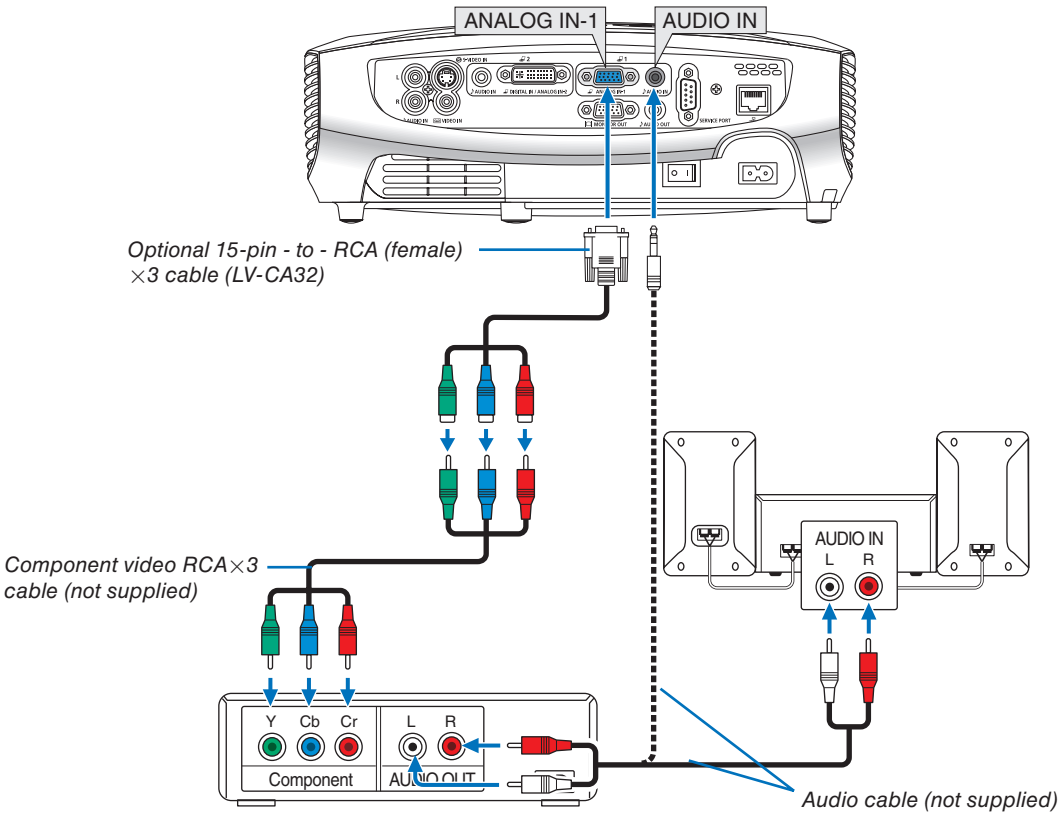

Connecting Your Audio-Video Equipment with Component Output

Use audio equipment for stereo sound.



A component signal will be automatically displayed. If not, from the menu, select [Setup] → [Options(1)] → [Input signal select] or [Computer 2 (Analog)] → [Computer 1], and then select [COMPONENT].

- Select the input name for its appropriate input connector after turning on the projector.

Input connector	Use the INPUT button on the projector cabinet or the remote control to select the appropriate input from the menu.
ANALOG IN-1	 Computer 1
DIGITAL IN / ANALOG IN-2	 Computer 2 (Analog)

NOTE: Refer to your DVD player's owner's manual for more information about your DVD player's video output requirements.

Connecting Your Audio-Video Equipment with Video/S-Video Output

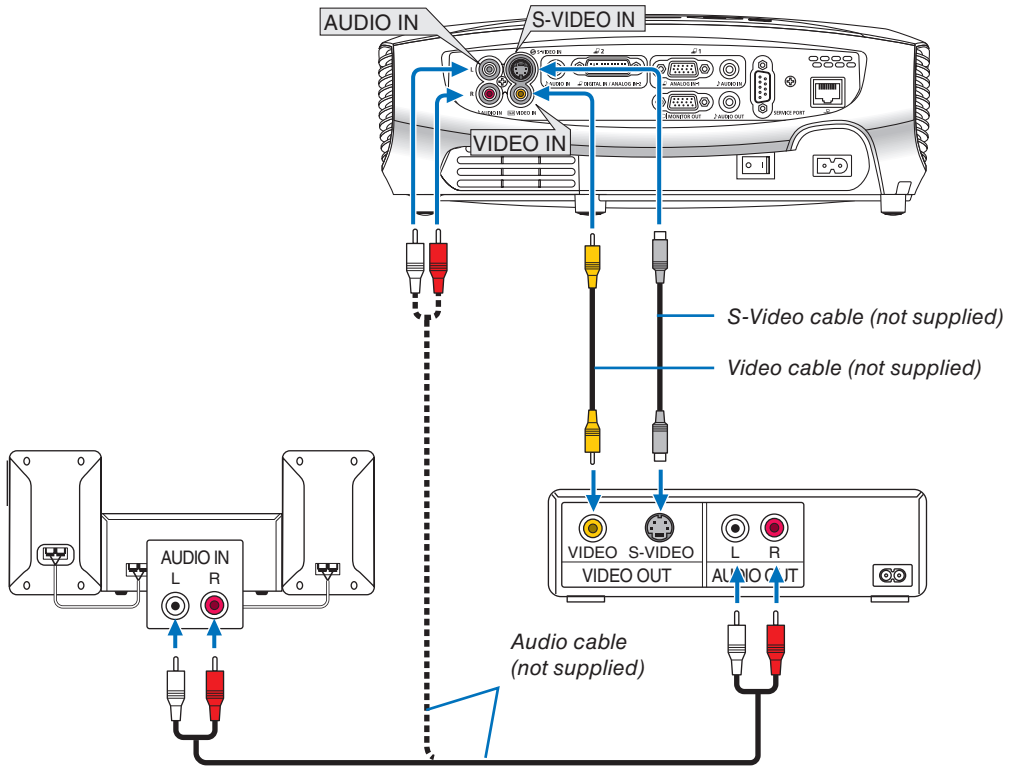

- Select the input name for its appropriate input connector after turning on the projector.

Input connector	Use the INPUT button on the projector cabinet or the remote control to select the appropriate input from the menu.
VIDEO IN	VIDEO
S-VIDEO IN	S-VIDEO

NOTE: The AUDIO IN L/MONO and R jacks (RCA) are shared between the Video and S-Video inputs.

NOTE: Refer to your audio-video equipment's owner's manual for more information about your equipment's video output requirements.

NOTE: An image may not be displayed correctly when a Video or S-Video source is played back in fast-forward or fast-rewind via a scan converter.

Connecting a Digital Video Signal

To project a source from audio video equipment with a digital video output such as an HDMI or DVI connector, use a commercially available HDMI-to-DVI cable or the optional DVI digital cable to connect the Computer 2 input [DIGITAL IN/ANALOG IN-2] connector of the projector as shown below.

To output the sound in stereo, connect to audio equipment.

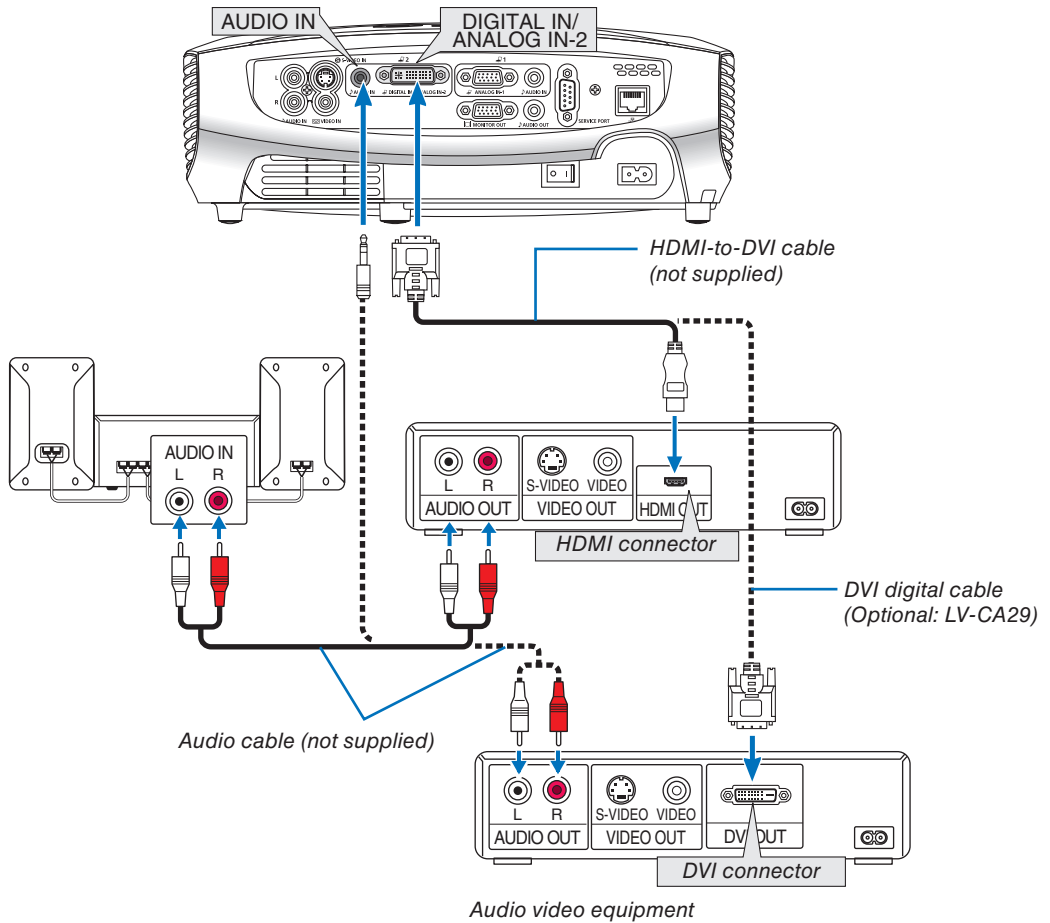

- Select the input name for its appropriate input connector after turning on the projector.

Input connector	Use the INPUT button on the projector cabinet or the remote control to select the appropriate input from the menu.
DIGITAL IN / ANALOG IN-2	 Computer 2 (Digital)

NOTE: An image may not be displayed depending on the specifications of the audio video equipment being used.

TIP: For users of audio video equipment with an HDMI connector:
 Select “Enhanced” rather than “Normal” if HDMI output is switchable between “Enhanced” and “Normal”.
 This will provide improved image contrast and more detailed dark areas.
 For more information on settings, refer to the instruction manual of the audio video equipment to be connected.

Connecting to a Network

The projector comes standard with a LAN port (LAN) which provides a LAN connection using a LAN cable. Using a LAN cable allows you to specify the Network Settings and the Alert Mail Settings for the projector over a LAN. To use a LAN connection, you are required to assign an IP address to the projector on the [PROJECTOR NETWORK SETTINGS] screen of the web browser on your computer. For setting, see page 43, 44, 45, 46.

Example of wired LAN connection

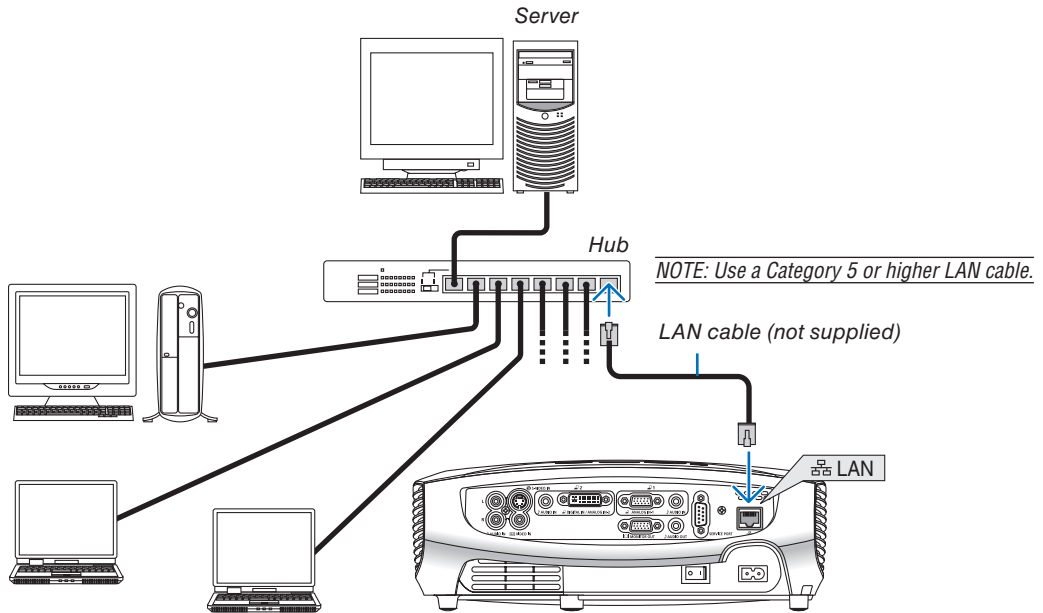

Connecting the Supplied Power Cord

Connect the supplied power cord to the projector.

First connect the supplied power cord's two-pin plug to the AC IN of the projector, and then connect the other plug of the supplied power cord in the wall outlet.

When you press the Main Power switch to the On position (I), the projector will go into standby mode. When in standby mode, the POWER indicator will light orange and the STATUS indicator will light green to show that [Normal] mode is selected for [Standby mode].

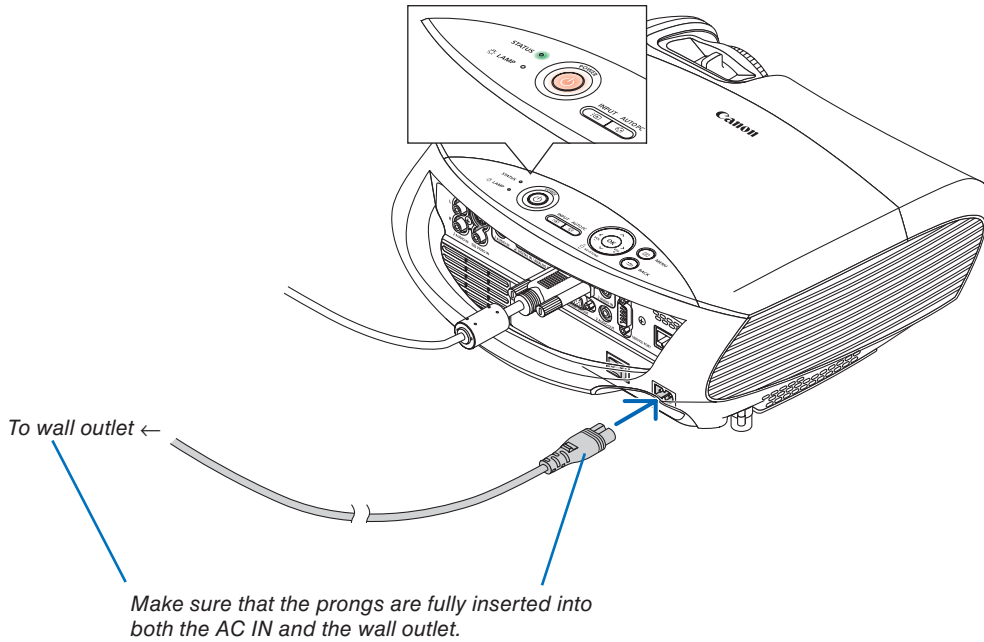

CAUTION:

Do not try to touch the ventilation outlet on the left front (when seen from the front) as it can become heated while the projector is turned on and immediately after the projector is turned off.

3. Projecting an Image (Basic Operation)

This section describes how to turn on the projector and to project a picture onto the screen.

1 Turning on the Projector

NOTE:

- The projector has two power switches: a main power switch and a POWER (⏻) button.
- When plugging in or unplugging the supplied power cord, make sure that the main power switch is pushed to the off (O) position. Failure to do so may cause damage to the projector.

1. To turn on the main power to the projector, press the Main Power switch to the on position (I).

- The projector will go into standby mode. When in standby mode, the POWER indicator will light orange and the STATUS indicator will light green to show that [Normal] mode is selected for [Standby mode].

2. Remove the lens cover.

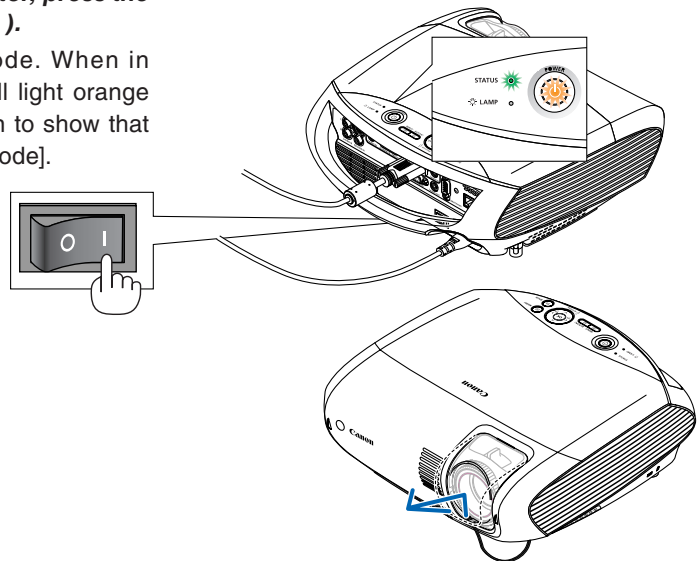

3. Press the POWER (⏻) button on the projector cabinet or the POWER (⏻) button on the remote control for about 1 second.

The STATUS indicator goes off and the POWER indicator starts blinking.

When the POWER indicator turns a steady green, and the projector is ready to use.

Less than 4 seconds* after turning on the power, the projector is ready to display PC or video images (Quick Start). The quick start time is only when [Standby mode] is set to [Normal] in the on-screen message.

If the projector is turned off and is turned it back on quickly, it may take some time to start displaying an image. This is because the fans run for cooling purpose.

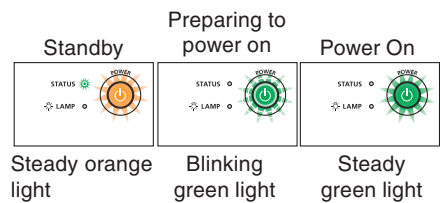
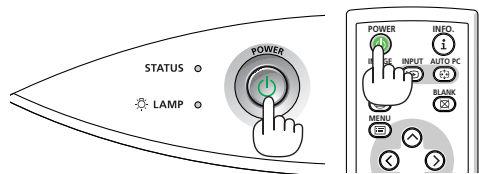

TIP: When the STATUS indicator lights orange, it means that the [Key lock] is turned on. See page 62.

- When the message "Projector is locked! Enter your password." is displayed, it means that the [Password] is turned on. See page 40.

After you turn on your projector, ensure that the computer or video source is turned on and that your lens cover is removed.

See page 74 for more details.

Note on Startup screen (Menu Language Select screen)

When you first turn on the projector, you will get the Startup menu. This menu gives you the opportunity to select one of the 21 menu languages.

To select a menu language, follow these steps:

1. Use the or button to select one of the 21 languages for the menu.

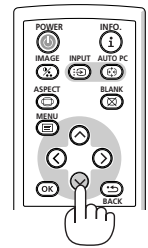
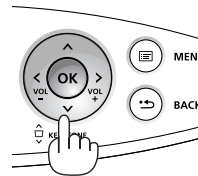

2. Press the OK button to execute the selection.

After this has been done, you can proceed to the menu operation.

If you want, you can select the menu language later. See [Language] on pages 49 and 60.

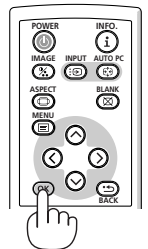
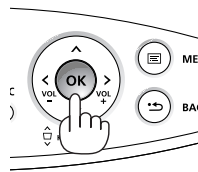

NOTE: Immediately after turning on the projector, screen flicker may occur. This is normal. Wait 3 to 5 minutes until the lamp lighting is stabilized.

NOTE: If you turn on the projector immediately after the lamp is turned off or when the temperature is high, the fans run without displaying an image for some time and then the projector will display the image.

CAUTION:

The projector cannot be turned off for 60 seconds after the lamp is turned on and while the POWER indicator is blinking green. Doing so could cause premature lamp failure.

When the Lamp mode is set to Quiet, the LAMP indicator will light green.

If one of the following things happens, the projector will not turn on.

- If the internal temperature of the projector is too high, the projector will not turn on to protect the internal system. Please wait for the projector's internal components to cool down.
- When the lamp reaches its end of usable life, the projector will not turn on. If this happens, replace the lamp.
- If the lamp fails to light, and if the STATUS indicator flashes on and off in a cycle of six times, wait a full minute and then turn on the power.

NOTE: Turning the Main Power Switch Off then Back On

Allow a minimum of 1 second between turning off the main power switch and turning it back on again.

The same will be applied when a power strip equipped with a switch and a breaker is used.

Failing to do so could result in no power to the projector. (There will be no stand-by LED)

Should this happen, unplug the power cord and plug it in again. Turn on the main power switch.

② Selecting a Source

Selecting the computer or audio-video equipment

NOTE: Turn on the computer or audio-video equipment connected to the projector.

Selecting from INPUT List

Press and quickly release the INPUT button on the projector cabinet to display the Source list. Each time the INPUT button is pressed, the input source will change as follows: "Computer 1", "Computer 2 (Digital/Analog)", "VIDEO", "S-VIDEO". To display the selected source, allow 1 second to elapse.

Detecting the Signal Automatically

Press and hold the INPUT button for a minimum of 2 seconds, the projector will search for the next available input source. Each time you press and hold the INPUT button for a minimum of 2 seconds, the input source will change as follows:

Computer 1 → Computer 2 (Digital) → Computer 2 (Analog) → VIDEO
→ S-VIDEO → Computer 1 → ...

TIP: If no input signal is present, the input will be skipped.

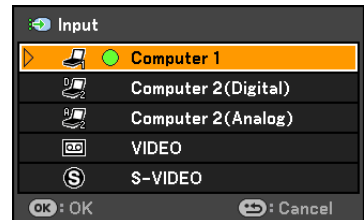
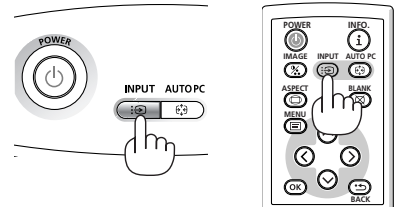

Selecting Default Source

You can set a source as the default source so that it will be displayed each time the projector is turned on.

1. Press the MENU button.

The menu will be displayed.

2. Press the \triangleright button twice to select [Setup] and press the \sphericalangle button or the OK button to select [General].

3. Press the \triangleright button four times to select [Options (2)].

4. Press the \sphericalangle button six times to select [Default Source Select] and press the OK button.

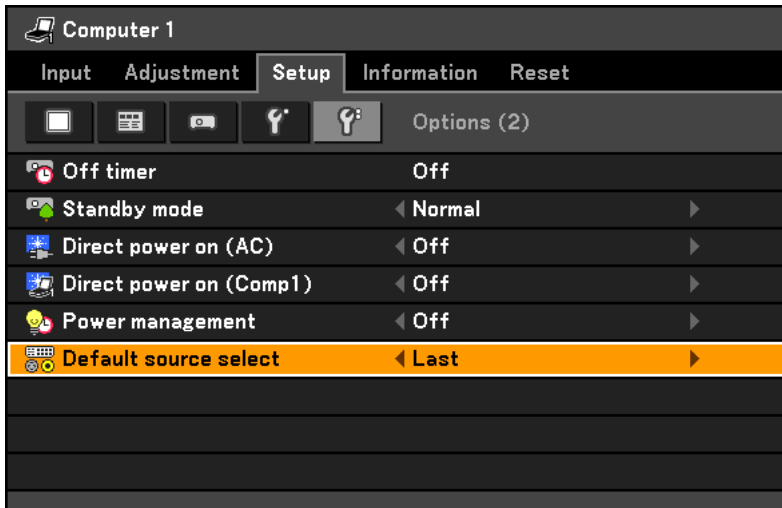

The [Default Source Select] screen will be displayed. See page 65.

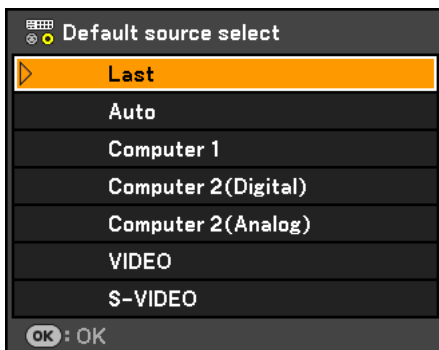

5. Select a source as the default source, and press the OK button.

6. Press the BACK button a few times to close the menu.

7. Restart the projector.

The source you selected in step 5 will be projected.

TIP: When the projector is in Standby mode, applying a computer signal from a computer connected to the ANALOG IN-1 input will power on the projector and simultaneously project the computer's image. ([Direct power on (Comp1)] See page 65.)

③ Adjusting the Picture Size and Position

Use the adjustable tilt foot, the zoom lever or the focus ring to adjust the picture size and position. In this chapter drawings and cables are omitted for clarity.

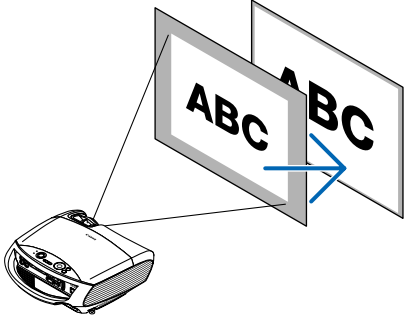
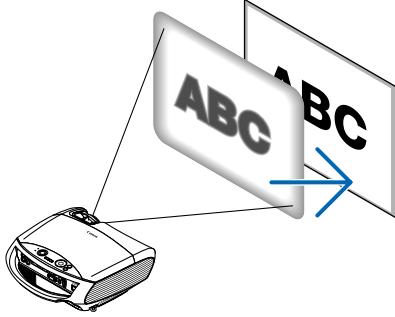
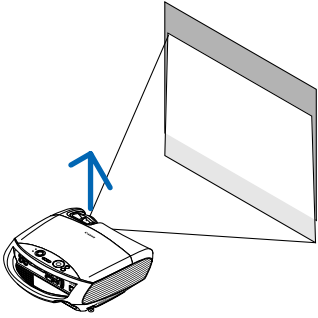
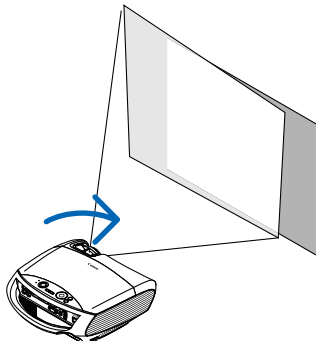
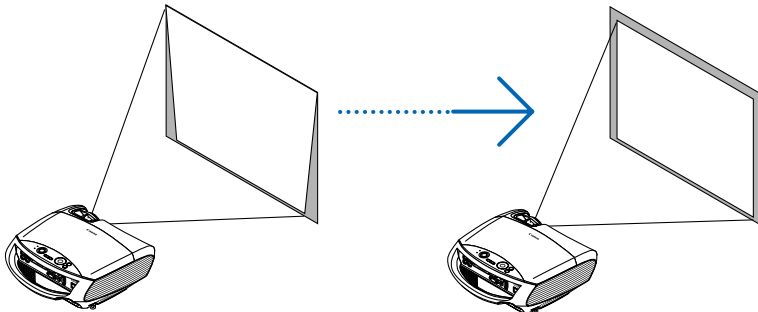
<p>Finely adjusting the size of an image [Zoom] (See page 29)</p> 	<p>Adjusting the focus [Focus] (See page 29)</p> 
<p>Adjusting the throw angle (the height of an image) "Adjusting the Tilt Foot" (See page 30)</p> 	<p>Adjusting the left and right tilt of an image "Adjusting the left and right tilt of an image [Rear foot]" (See page 30)</p> 
<p>Adjusting the keystone correction "Correcting Keystone Distortion"* (See page 32, 33)</p> 	

* Keystone correction can be also performed automatically. See page 31.

3. Projecting an Image (Basic Operation)

Zoom

Use the ZOOM lever to adjust the image size on the screen.

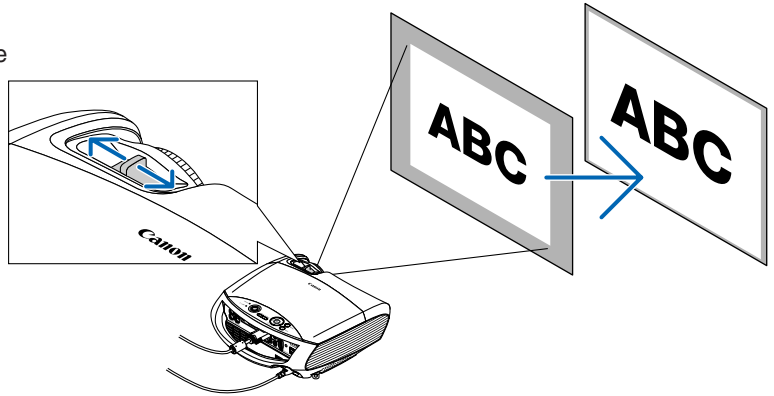

Focus

Use the FOCUS ring to obtain the best focus.

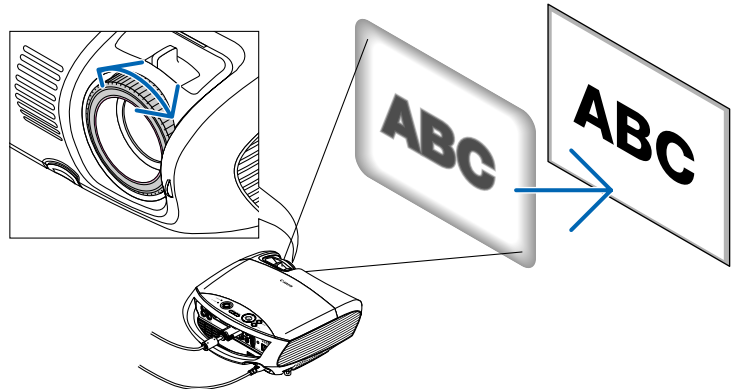

Adjusting the Tilt Foot

1. Lift the front edge of the projector.

⚠ CAUTION:

Do not try to touch the ventilation outlet during Tilt Foot adjustment as it can become heated while the projector is turned on and during its cool down period after it is turned off.

2. Push straight up and hold the Adjustable Tilt Foot Lever on the front of the projector to extend the adjustable tilt foot.

3. Lower the front of the projector to the desired height.

4. Release the Adjustable Tilt Foot Lever to lock the Adjustable tilt foot.

The tilt foot can be extended up to 1.8 inch/45 mm.

There is approximately 10 degrees (up) of adjustment for the front of the projector.

Rotate the rear foot to the desired height in order to square the image on the projection surface.

⚠ CAUTION:

- Do not use the tilt-foot for purposes other than originally intended. Misuses such as using the tilt foot to carry or hang (from the wall or ceiling) the projector can cause damage to the projector.

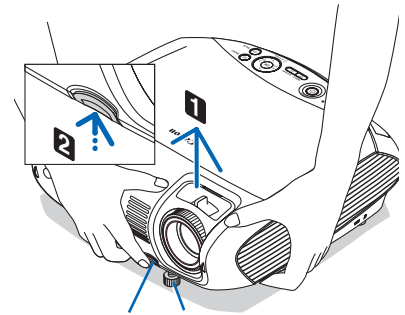

Adjustable Tilt Foot Lever

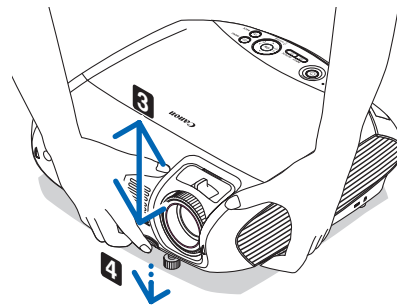

Adjusting the left and right tilt of an image [Rear foot]

1. Remove the spacer (black rubber) from the rear foot.

A spacer is provided for leveling the projector. Keep the spacer for future use.

2. Rotate the rear foot.

The rear foot can be extended up to 0.4 inch/10 mm. Rotating the rear foot allows the projector to be placed horizontally.

NOTE:

- Do not extend the rear foot beyond its height limit (0.4 inch/10 mm). Doing so may cause the rear foot to come out of the projector.
- After using the projector, attach the spacer to the rear foot.

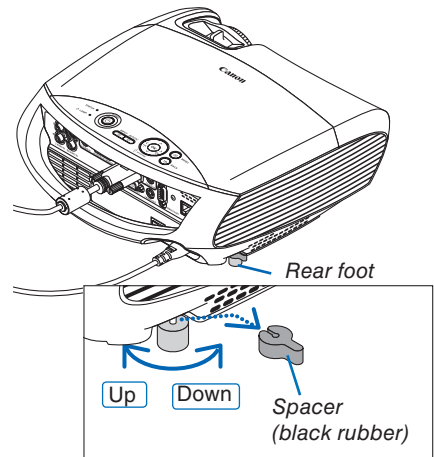
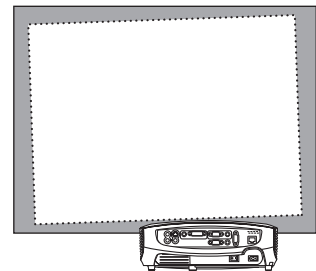

④ Correcting Keystone Distortion

Correcting Keystone Distortion

If the screen is tilted vertically, keystone distortion becomes large. Proceed with the following steps to correct keystone distortion

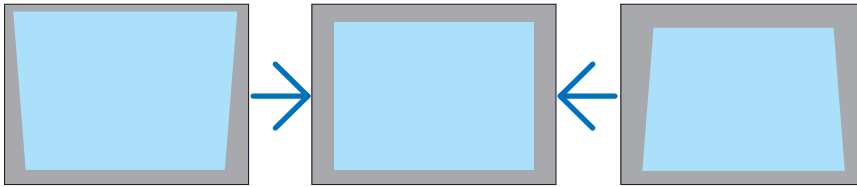

Adjusting with the Auto Keystone Function

The Auto Keystone correction feature will correct the vertical distortion of a projected image on the screen. No special operation required. Just put the projector on a flat surface.

TIP: Even when the menu setting for [Auto keystone] is turned on, [Keystone adjustment] can be adjusted manually.

To turn off [Auto keystone], proceed the following steps.

1. Press the MENU button

The menu will be displayed.

2. Press the \triangleright button to select [Setup] and press the OK button.

The [General] tab will be highlighted.

3. Press the \sphericalangle button.

The [Auto keystone] will be highlighted.

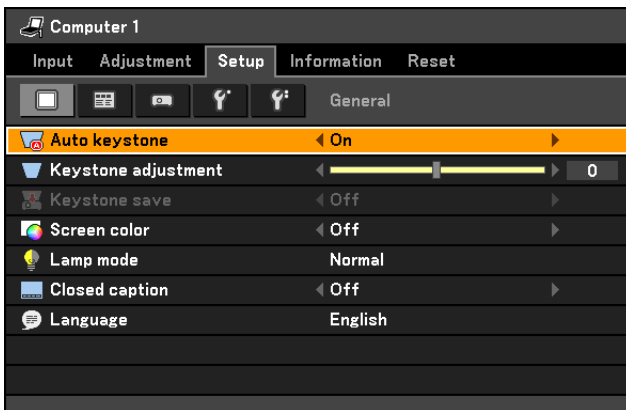

4. Press the OK button to display the [Auto keystone] screen.

5. Press the \sphericalangle or \triangleright button to select [Off] and press the OK button.

6. Press the MENU button.

The menu will be closed.

NOTE:

- Vertical distortions between offset angles of +/- 30 degrees can be corrected.
The range of keystone correction is not the maximum tilt angle of projector.
- The Auto Keystone correction will take effect in 2 seconds after changing the projection angle during projection.
- The left and right (horizontal) keystone correction is not available.

Place the projector so that the lens surface is parallel to the screen.

The rear feet of the projector can be adjusted to level the projector.

3. Projecting an Image (Basic Operation)

NOTE:

- Auto and Manual Keystone correction angle could be less than 30 degrees depending on the signal and/or aspect ratios.
- Using keystone correction can cause the image to be slightly blurred because the correction is made electronically.

NOTE:

- When the menu is displayed, the Keystone Correction operation is not available by using the buttons on the projector cabinet. When the menu is displayed, press the BACK button to close the menu and then perform the Keystone correction.
- From the menu, select [Setup] → [General] → [Keystone adjustment]. The changes can be saved with [Keystone save]. See page 59.

NOTE: If you have one of the following conditions, the projector's Auto Keystone may not be performed correctly.

- the screen is tilted
- the room temperature is too high or too low
- the optical zoom is maximized or minimized

NOTE: The Keystone correction can cause an image to be slightly blurred because the correction is made electronically.

NOTE: The Keystone correction range can be made narrower, depending on a signal or its aspect ratio selection.

NOTE: Turning off the projector will cause your manual keystone adjustments to return to "0". To save your manual keystone adjustments, first turn off [Auto keystone] and then turn on [Keystone save]. See page 59.

Adjusting with buttons on the cabinet

1. Press the  or  button with no menus displayed

The keystone bar will be displayed.



2. Use the  or  to correct the keystone distortion.

The keystone bar will be closed after a period of time.

NOTE: When the menu is displayed, the above operation is not available. When the menu is displayed, press the MENU button to close the menu and start the Keystone correction.

From the menu, select [Setup] → [General] → [Keystone adjustment]. The changes can be saved with [Keystone save]. See page 59.

Adjusting with the Remote Control

1. Press the **MENU** button.

The menu will be displayed.

2. Press the **⏪** button to select [Setup] and press the **OK** or **⏩** button.

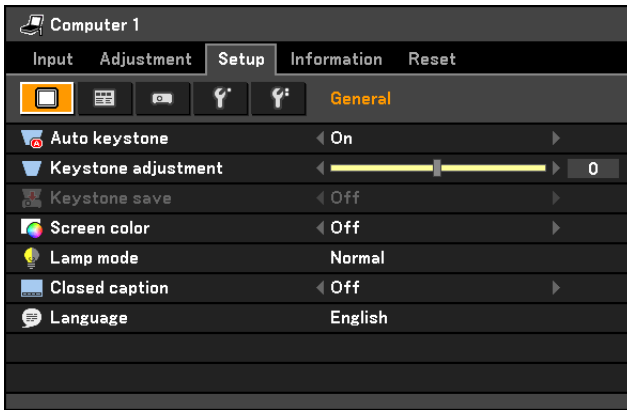

3. Press the **⏩** button to select [Keystone adjustment] from the [General] tab.

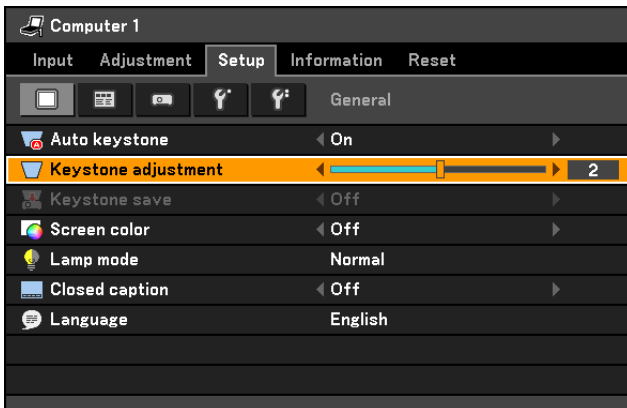

4. Press the **⏪** or **⏩** button.

Adjust so that the image is rectangular.

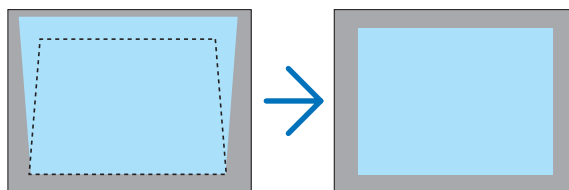

5. Press the **MENU** button.

The menu will be closed.

5 Automatically Optimizing on RGB Image

Adjusting the Image Using Auto PC adjustment

Optimizing an RGB image automatically.

Press the AUTO PC button to optimize an RGB image automatically.

[Poor picture]

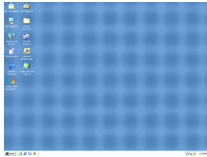

[Normal picture]

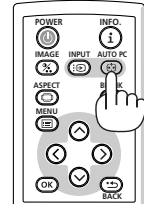
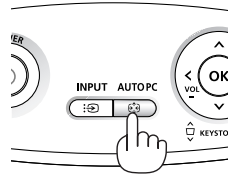
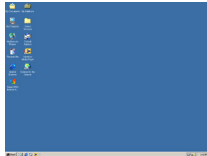

Press the AUTO PC button to fine-tune the computer image or to remove any vertical banding that might appear and to reduce video noise, dot interference or cross talk (this is evident when part of your image appears to be shimmering). This function adjusts the clock frequencies that eliminate the horizontal banding in the image. This function also adjusts the clock phase to reduce video noise, dot interference or cross talk. (This is evident when part of your image appears to be shimmering.)

This adjustment may be necessary when you connect your computer for the first time.

NOTE:

Some signals may not be displayed correctly or take time.

- The Auto PC adjustment function does not work for component, video, and DVI digital signals.
- If the Auto PC adjustment operation cannot optimize the RGB signal, try to adjust Horizontal/Vertical Position Clock and Tracking manually. See page 54, 55.

6 Turning Up or Down Volume

Sound level from the speaker can be adjusted.

Decrease volume — Increase volume

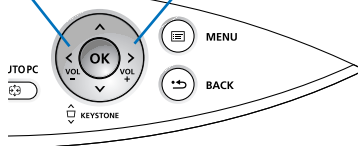

Increase volume
Decrease volume

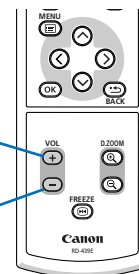

TIP:

- When no menus appear, the ◀ and ▶ buttons on the projector cabinet work as a volume control.
- The [Beep] sound volume cannot be adjusted. To turn off the [Beep] sound, from the menu, select [Setup] → [Options (1)] → [Beep] → [Off].

NOTE:

- Volume control is not available with the ◀ or ▶ button when an image is enlarged by using the D.ZOOM (+) button or when the menu is displayed.
- Sound volume can be adjusted and saved for each input separately.

7 Turning off the Projector

To turn off the projector:

1. Press the **POWER** (⏻) button on the projector cabinet or the remote control. The “Push **POWER** button again to turn off power. /Carbon savings-Session 23.220(g-CO2)” message will appear. See page 39. Amount of carbon emission reduction will be displayed only when [Lamp mode] is set to [Quiet]. When [Lamp mode] is set to [Normal], the amount of carbon emission reduction will be displayed as “00.000 (g-CO2)”.

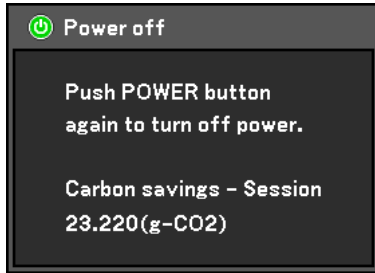
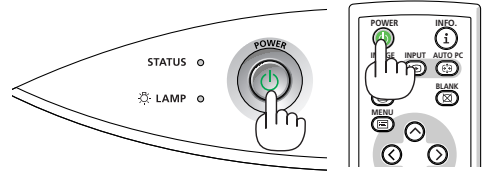

2. Press the **POWER** button again.

The projector turns off and goes into standby mode.

When in standby mode, the **POWER** indicator will light orange (the cooling fans stop at the same time) and the **STATUS** indicator will light green.

3. Turn off the Main Power switch. The **POWER** indicator will go out.

The projector has a feature called “Direct Power Off”. This feature allows the projector to be turned off (even when projecting an image) by using the Main Power Switch or disconnecting the AC power supply. To turn off the AC power supply when the projector is powered on, use the Main Power Switch, or a power strip equipped with a switch and a breaker.

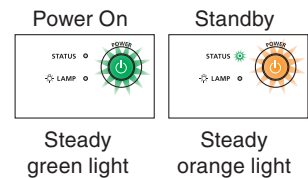

NOTE: Do not turn off the main power within 10 seconds of making adjustment or setting changes and closing the menu. Doing so can cause loss of adjustments and settings.

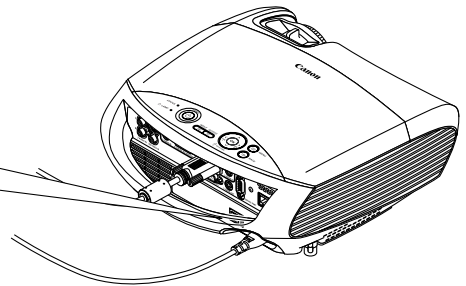
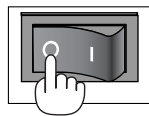

⚠ CAUTION:

Parts of the projector will become heated during operation. Use caution when picking up the projector immediately after it has been operating.

⚠ CAUTION:

- The projector cannot be turned off for 60 seconds after the lamp is turned on and while the **POWER** indicator is blinking green. Doing so could cause premature lamp failure.

8 After Use

Preparation: Make sure that the projector is turned off.

1. **Unplug the power cord.**
2. **Disconnect any other cables.**
3. **Retract adjustable tilt feet if extended.**
 - Reattach the spacer (black rubber) to the rear foot if it was removed.
4. **Cover the lens with the lens cover.**

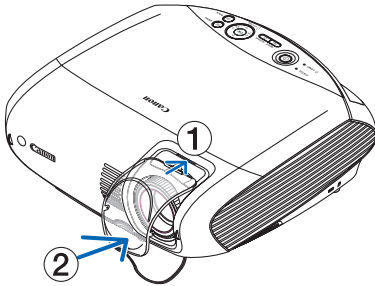

5. **Put the projector and its accessories in the supplied soft case.**

NOTE: When placing the projector in the soft case, retract the tilt feet and the rear feet. Failure to do so may cause damage to the projector.

CAUTION:

Use caution when putting the projector in the soft case immediately after the projector has been operating. The projector cabinet is hot.

4. Convenient Features

1 Turning off the Image and Sound

Press the BLANK button to turn off the image and sound for a short period of time. Press again to restore the image and sound.

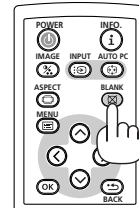

2 Freezing a Picture

Press the FREEZE button to freeze a projected moving picture such as DVD. Press again to resume motion.

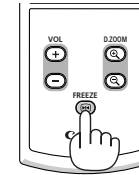

3 Enlarging a Picture

You can enlarge the picture up to 400 percent.

NOTE: The maximum magnification may be less than four times depending on the signal.

To do so:

1. Press the D. ZOOM (+) button to magnify the picture.

To move the magnified image, use the  button.

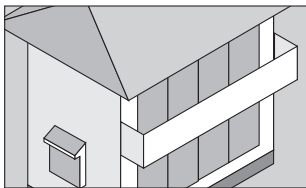
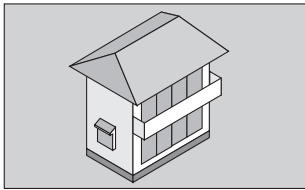

2. Press the  button.

The area of the magnified image will be moved.

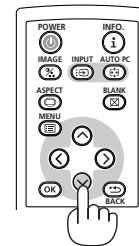
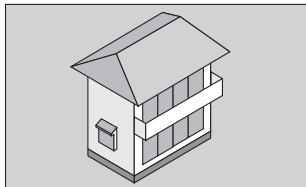

3. Press the D.ZOOM(-) button.

Each time the D.ZOOM(-) button is pressed, the image is reduced.

NOTE:

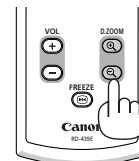

- The image will be enlarged or reduced at the center of the screen.
- Displaying the menu will cancel the current magnification.



④ Lamp Mode and Energy-Saving Effect

Selecting [Quiet] for Lamp mode will help you to reduce CO₂ emissions from the projector.

The Lamp mode enables you to select two brightness modes of the lamp: Normal and Quiet modes. The lamp life can be extended by using the Quiet mode.

Lamp Mode	Description	Status of LAMP indicator	
Normal Mode	This is the default setting (100% Brightness).	Off	
Quiet Mode	Select this mode to increase the lamp life (LV-7385/LV-8310/LV-8215: approx.75% Brightness/LV-7380/LV-7285/LV-7280: approx.80% Brightness).	Steady Green light	

Changing Lamp Mode

To change the [Lamp mode] from [Normal] to [Quiet], do the following:

1. Press the MENU button on the remote control to display the menu.
2. Select [Setup] → [General] → [Lamp mode].
3. Press the ENTER button to display the Lamp mode menu.
4. Press the  button to select [Quiet] and press the OK button.
5. Press the OK button to close the menu.

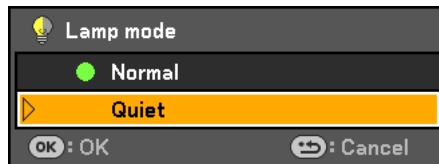

NOTE:

- The projector has the Eco message function that will show the status of Quiet mode on screen. Select [Setup] → [Menu] → [Eco message] → [On]. See page 60, 61.
- The lamp life remaining and lamp hours used can be checked in [Usage time]. Select [Information] → [Usage time]. See page 66.
- The projector will only operate in the [Quiet] mode for 90 seconds immediately after the lamp is turned on. The lamp condition will not be affected even when [Lamp mode] is changed.
- If there is no signal for about one minute, the projector will display a blue, black or logo background (depending on setting) and go into [Quiet].
The projector will return to the [Normal] mode once a signal is accepted.
- If the projector is overheated in Normal mode, there may be a case where the Lamp mode automatically changes to Quiet mode to protect the projector. This is called "forced cooling operation". When the projector is in a forced cooling operation, the picture brightness decreases. When the projector comes back to normal temperature, the Lamp mode returns to Normal mode.
Thermometer symbol  indicates the lamp mode is automatically set to a forced cooling operation because the internal temperature is too high. In this condition, changing [Lamp mode] setting in the menu will not affect the actual lamp mode and the LAMP indicator lights green.

Checking Energy-Saving Effect

This feature will show energy-saving effect in terms of CO₂ emission reduction (kg) when the projector's [Lamp mode] is set to [Quiet]. This feature is called as [Carbon meter].

There are two messages: [Total carbon savings] and [Carbon savings-Session]. The [Total carbon savings] message shows the total amount of CO₂ emission reduction from the time of shipment up to now. You can check the information on [Usage time] from [Information] of the menu. See page 66.

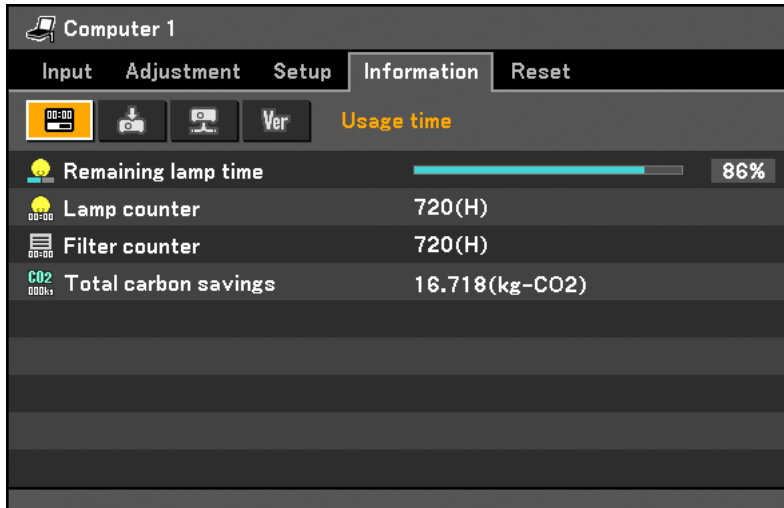

The [Carbon savings-Session] message shows the amount of CO₂ emission reduction between the time of changing to [Quiet] mode immediately after the time of power-on and the time of power-off. The [Carbon savings-Session] message will be displayed in the [Push POWER button again to turn off power/ Carbon savings-Session/23.220(g-CO₂)] message at the time of power-off.

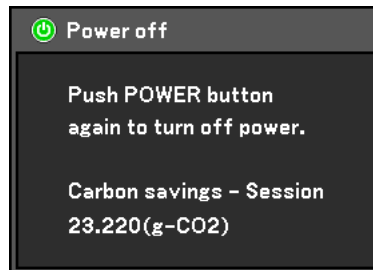

TIP:

- The formula as shown below is used to calculate the amount of CO₂ emission reduction. Amount of CO₂ emission reduction = Power consumption in [Quiet] for [Lamp mode] – Power consumption in [Quiet] for Lamp mode x CO₂ conversion factor.*
- * Calculation for amount of CO₂ emission reduction is based on an OECD publication "CO₂ Emissions from Fuel Combustion, 2008 Edition".
- This formula will not apply to the power consumption which is not affected by whether [Lamp mode] is set to [Quiet] or not.

5 Preventing the Unauthorized Use of the Projector [Password]

A password can be set for your projector to avoid operation by an unauthorized user using the Menu. When a password is set, turning on the projector will display the password input screen. Unless the correct password is entered, the projector cannot project an image.

NOTE: The [Password] setting cannot be cancelled by using the [Reset] of the menu.

To enable the Password function:

1. Press the MENU button.

The menu will be displayed.

2. Press the \odot button twice to select [Setup] and press the \ominus button or the OK button to select [General].

3. Press the \odot button twice to select [Installation].

4. Press the \ominus button three times to select [Password] and press the OK button.

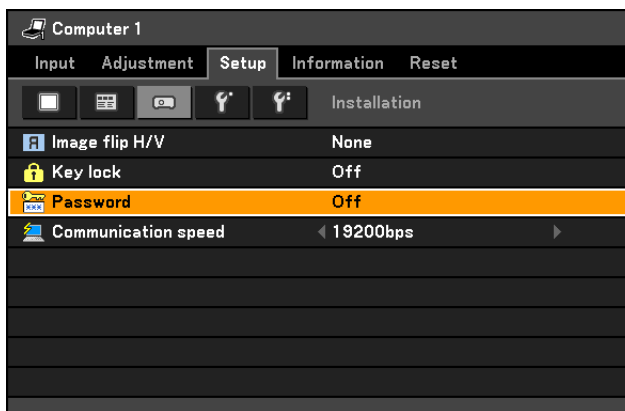

The Off/On menu will be displayed.

5. Press the \ominus button to select [On] and press the OK button.

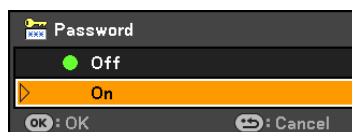

The [Password] screen will be displayed.

6. Type in a combination of the four \uparrow \downarrow \leftarrow \rightarrow buttons and press the OK button.

To cancel this operation, press the MENU button.

NOTE: A password must be 4 to 10 digits in length. Please make a note of your password.

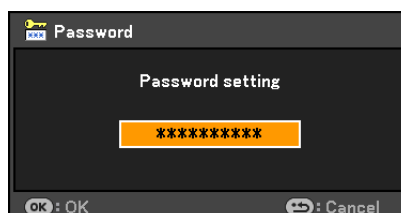

The [Confirm password] screen will be displayed.

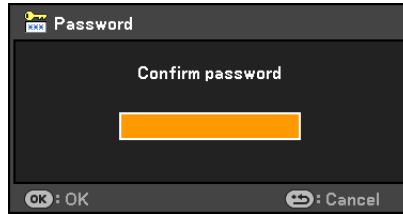

NOTE: Do not forget your password. If you forget your password, contact your dealer.

7. Type in the same combination of \triangle \square \circ \diamond buttons and press the OK button.

The confirmation screen will be displayed.

8. Select [Yes] and press the OK button.

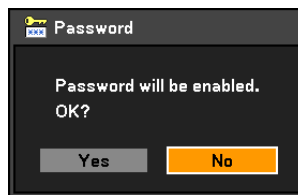

The Password function has been enabled.

To turn on the projector when Password is enabled:

1. Press the Main Power Switch to the On position (I).

2. Press and hold the POWER button for about 1 second.

The projector will be turned on and display a message to the effect that the projector is password-protected.

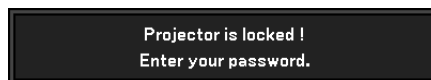

3. Press the MENU button.

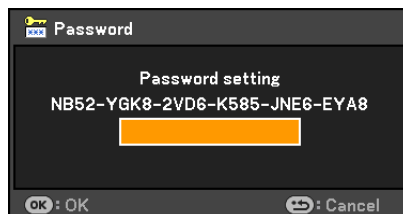

The Password screen will be displayed.

4. Enter your password in the Password screen and press the OK button.

You can view the projected image.

NOTE: The password disable mode is maintained until the main power is turned off (by setting the main power switch to "O" or unplugging the power cord). Turning off the main power and turning it back on will require password entry.

To disable the Password function:**1. Press the MENU button.**

The menu will be displayed.

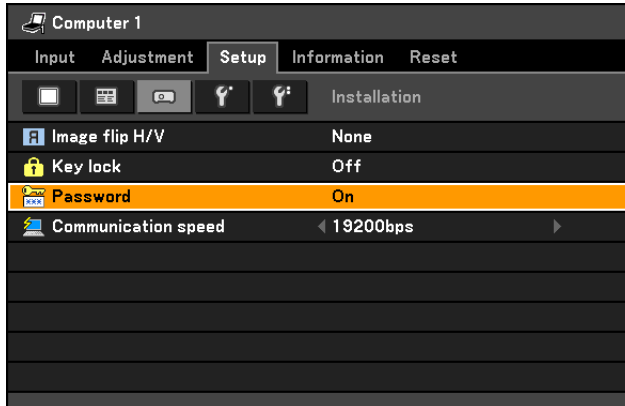
2. Select [Setup] → [Installation] → [Password] and press the OK button.

The Off/On menu will be displayed.

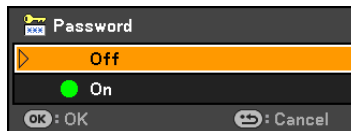
3. Select [Off] and press the OK button.

The Password Confirmation screen will be displayed.

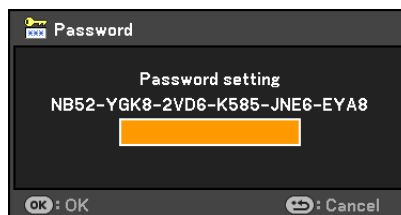
**4. Type in your password and press the OK button.**

When the correct password is entered, the Password function will be disabled.

NOTE: If you forget your password, contact your dealer.

⑥ Network and Alert Mail Settings by Using an HTTP Browser

Overview

Connecting the projector to a network allows the projector to send an alert mail that informs the user that the lamp has reached the end of its life or an error has occurred.

The IP address and subnet mask of the projector can be set on the Network Setting screen of the web browser by using an HTTP server function. Please be sure to use “Microsoft Internet Explorer 6.0” or a higher version for the web browser. (This device uses “JavaScript” and “Cookies” and the browser should be set to accept these functions. The setting method will vary depending on the version of browser. Please refer to the help files and the other information provided in your software.)

Access is gained to the HTTP server function by starting the Web browser on the computer via the network connected to the projector and enter the following URL.

- Network Setting
http://<the projector's IP address>/index.html
- Alert Mail Setting
http://<the projector's IP address>/lanconfig.html

Example : Network Setting
 http://192.168.0.10/index.html

 Alert Mail Setting
 http://192.168.0.10/lanconfig.html

TIP: The default IP address is “192.168.0.10”.

NOTE:

- If the **PROJECTOR NETWORK SETTINGS** screen does not appear in the web browser, press the **Ctrl+F5** keys to refresh your web browser (or clear the cache).
 - The display's or button's response can be slowed down or operation may not be accepted depending the settings of your network. Should this happen, consult your network administrator.
The projector may not respond if its buttons are repeatedly pressed in rapid intervals. Should this happen, wait a moment and repeat. If you still can't get any response, turn off and back on the projector.
-

Preparation Before Use

Connect the projector to a commercially available LAN cable before engaging in browser operations. See page 22. Operation with a browser that uses a proxy server may not be possible depending on the type of proxy server and the setting method. Although the type of proxy server will be a factor, it is possible that items that have actually been set will not be displayed depending on the effectiveness of the cache, and the contents set from the browser may not be reflected in operation. It is recommended that a proxy server not be used unless it is unavoidable.

Network Settings

http://<the projector's IP address> /index.html

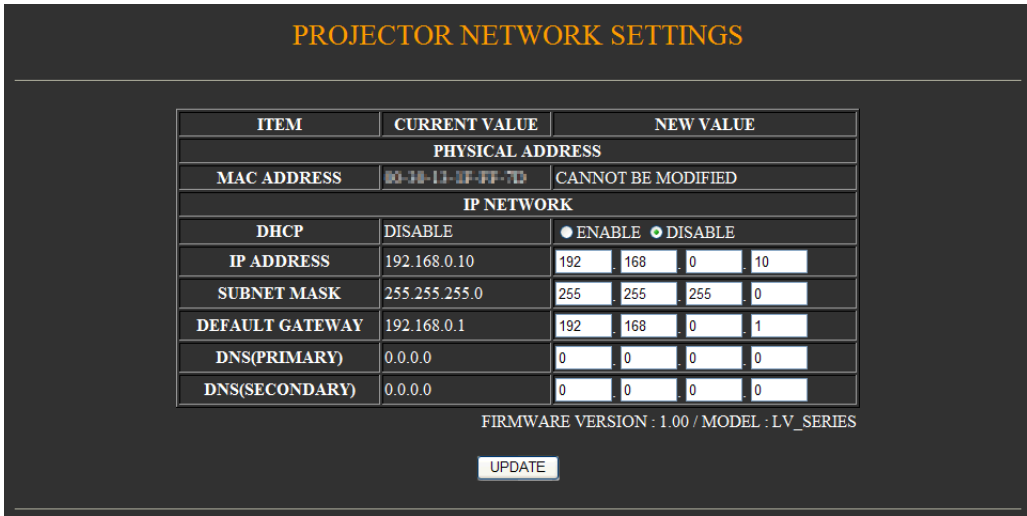

DHCP.....Enabling this option automatically assigns an IP address to the projector from your DHCP server. Disabling this option allows you to register the IP address or subnet mask number obtained from your network administrator.

NOTE: You can check the IP address in the menu when [ENABLE] is selected for [DHCP]. To do so, from the menu, select [Information] → [Wired LAN].

IP ADDRESS.....Set your IP address of the network connected to the projector when [DISABLE] is selected for [DHCP].

NOTE: You can check your specified IP address in the menu. To do so, from the menu, select [Information] → [Wired LAN].

SUBNET MASK.....Set your subnet mask number of the network connected to the projector when [DISABLE] is selected for [DHCP].

DEFAULT GATEWAY.....Set your default gateway of the network connected to the projector when [DISABLE] is selected for [DHCP].

DNS (PRIMARY)Set your primary DNS settings of the network connected to the projector.

DNS (SECONDARY).....Set your secondary DNS settings of the network connected to the projector.

UPDATE.....Reflect your settings.

NOTE: Close the browser after clicking [UPDATE]. The projector will automatically update your settings.

TIP: Selecting [Network settings] for [Reset] from the projector's menu allows you to return the following items to the factory default.

[DHCP]: DISABLE

[IP ADDRESS]: 192.168.0.10

[SUBNET MASK]: 255.255.255.0

[DEFAULT GATEWAY]: 192.168.0.1

*[DNS(PRIMARY)] and [DNS(SECONDARY)] will remain unchanged.

Alert Mail Setting

http:// <the projector's IP address>/lanconfig.html

This option notifies your computer of an error message via e-mail when using wired LAN. An error message notification will be sent when the projector lamp has reached the end of its usable life or an error occurs in the projector.

- HOST NAME Type in the hostname of the network connected to the projector. Up to 60 alphanumeric characters can be used. If the host name is unknown, type in a string of characters representing the projector. Example: Projector 1
- DOMAIN NAME Type in the domain name of the network connected to the projector. Up to 60 alphanumeric characters can be used. If the domain name is unknown, type in the right side of @ in the sender's address. Example: canon.com
- ALERT MAIL..... Checking [ENABLE] will turn on the Alert Mail feature.
Checking [DISABLE] will turn off the Alert Mail feature.
- SENDER'S ADDRESS Type in the senders address. Up to 60 alphanumeric and symbols characters can be used.
- SMTP SERVER NAME..... Type in the SMTP server name to be connected to the projector. Up to 60 alphanumeric characters can be used.
- RECIPIENT'S ADDRESS 1 to 3 ... Type in your recipient's address. Up to 60 alphanumeric and symbols characters can be used.
- APPLY Click this button to reflect the above settings
- EXECUTE..... Click this button to send a test mail to check if your settings are correct.
- STATUS A reply to a test mail will be displayed.

NOTE:

- If you execute a test, you may not receive an Alert mail. Should this happen, check if the network settings are correct.
- If you entered an incorrect address in a test, you may not receive an Alert mail. Should this happen, check if the Recipient's Address is correct

TIP: The Alert Mail settings will not be affected even when [Reset] is done from the menu.

List of Error Messages

Subject/Body	Projector status	Message
Message subject	At the time of sending test mail	[Projector] Test mail
	At the time when error is found	[Projector] Projector information
Message body	Test mail	Alert mail configurations are as follows: Model name: Serial number: Sender's address: SMTP server name: Recipient's address 1: Recipient's address 2: Recipient's address 3:
	Lamp replacement	Replace with the new lamp. [Information] Model name: Serial number: Lamp counter:
	Filter cleaning	Please clean filter. [Information] Model name: Serial number: Filter counter: Lamp counter:
	Lamp cover error	The lamp cover is not installed properly. Check and re-attach it if necessary. [Information] Model name: Serial number: Lamp counter:
	Cooling fan error	The cooling fan has stopped. [Information] Model name: Serial number: Lamp counter:
	Lamp error	The lamp will not turn on. [Information] Model name: Serial number: Lamp counter:
	Temperature error	The projector is overheated. [Information] Model name: Serial number: Lamp counter:
	Iris calibration error	The calibration of the iris has failed. [Information] Model name: Serial number: Lamp counter:

5. Using On-Screen Menu

① Using the Menus

NOTE: The on-screen menu may not be displayed correctly while interlaced motion video image is projected.

1. Press the **MENU** button on the remote control or projector cabinet to display the Menu.

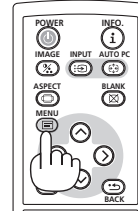
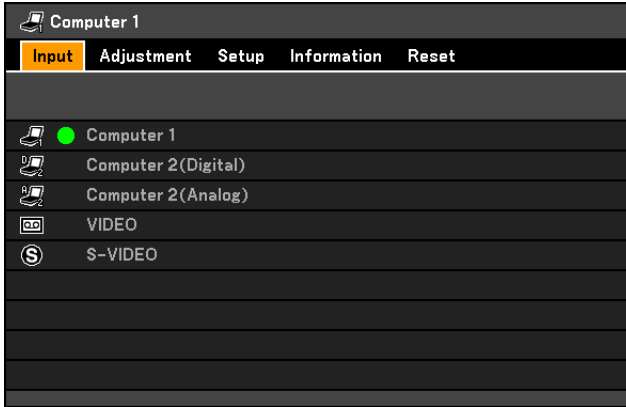

2. Press the **◀▶** buttons on the remote control or the projector cabinet to display the submenu.
3. Press the **OK** button on the remote control or the projector cabinet to highlight the top item or the first tab.
4. Use the **▲▼** buttons on the remote control or the projector cabinet to select the item you want to adjust or set.
You can use the **◀▶** buttons on the remote control or the projector cabinet to select the tab you want.
5. Press the **OK** button on the remote control or the projector cabinet to display the submenu window.
6. Adjust the level or turn the selected item on or off by using the **◀▶◀▶** buttons on the remote control or the projector cabinet.
Changes are stored until adjusted again.
7. Repeat steps 2 -6 to adjust an additional item, or press the **BACK** button on the remote control or the projector cabinet to quit the menu display.

NOTE: When a menu or message is displayed, several lines of information may be lost, depending on the signal or settings.

8. Press the **MENU** button to close the menu.
To return to the previous menu, press the **BACK** button.

2 Menu Elements

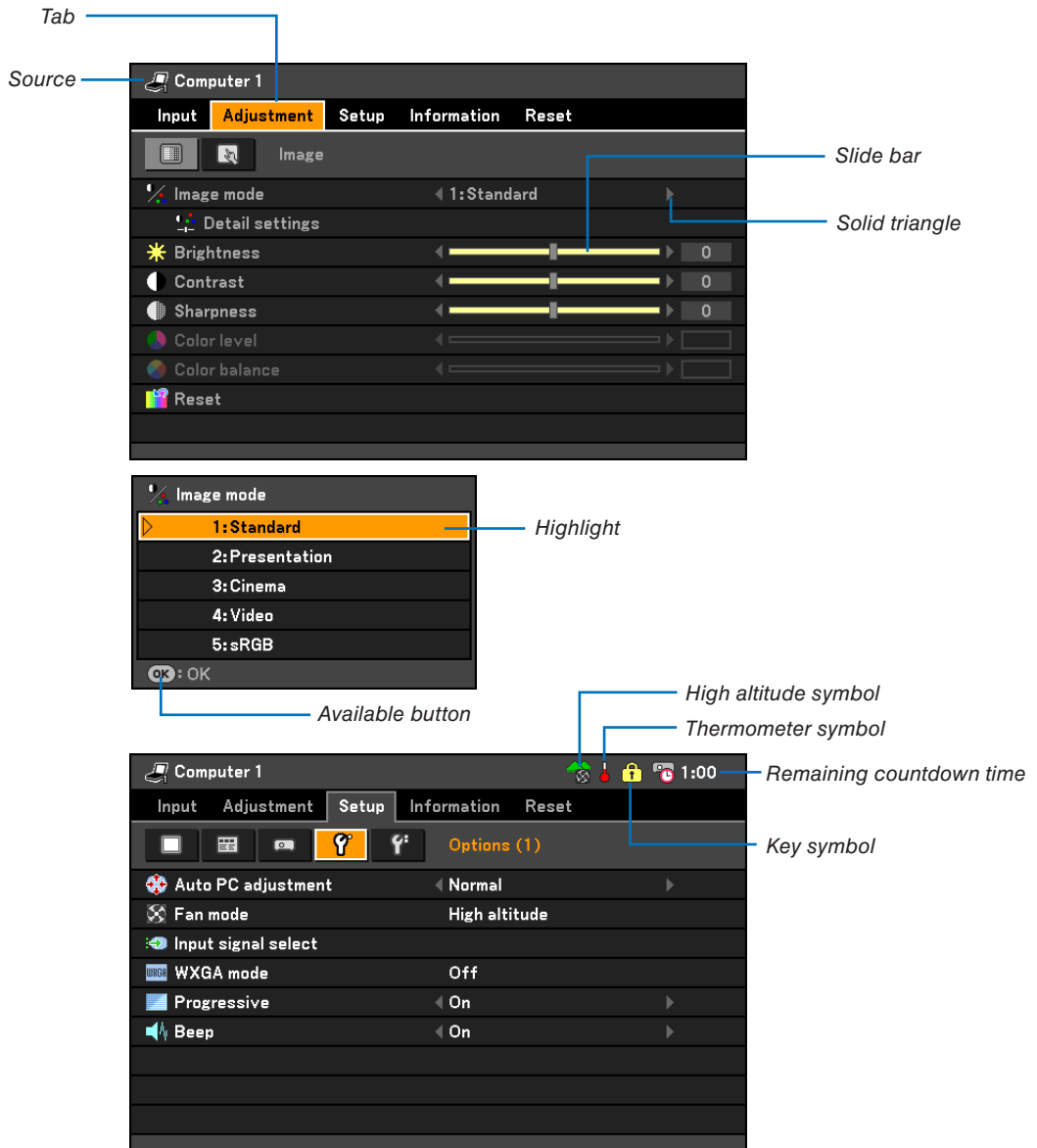

Menu windows or dialog boxes typically have the following elements:

- Highlight.....Indicates the selected menu or item.
- Source.....Indicates the currently selected source.
- Slide bar.....Indicates settings or the direction of adjustment.
- Tab.....Indicates a group of features in a dialog box. Selecting on any tab brings its page to the front.
- Available buttons.....Indicates currently available buttons on the projector cabinet or the remote control.
- Solid triangle.....Indicates further choices are available. A highlighted triangle indicates the item is active.
- Key symbol.....Indicates the Key Lock is enabled.
- Thermometer symbol.....Indicates the lamp is forcibly being cooled down because the internal temperature is too high.
- High altitude symbol.....Indicates the [Fan mode] is set to [High altitude] mode.
- Remaining countdown time.....Indicates the remaining countdown time when the Off Timer is preset.

3 List of Menu Items

Some menu items are not available depending on the input source.

Menu Item		Factory default	Options	
Input	Computer 1	*		
	Computer 2 (Digital)	*		
	Computer 2 (Analog)	*		
	VIDEO	*		
	S-VIDEO	*		
Adjustment	Image	Image mode	* 1:Standard, 2:Presentation, 3:Cinema, 4:Video, 5:sRGB	
		Detail settings	Reference	* Standard, Presentation, Cinema, Video, sRGB
			Gamma	Dynamic, Natural, Black detail
			Color temperature	* 5000K, 6500K, 7300K, 8300K, 9300K, 10500K
			Auto iris (LV-7285/LV-7280)	Off, On
			Brightness R Brightness G Brightness B Contrast R Contrast G Contrast B	*
	Brightness			
	Contrast			
	Sharpness			
	Color level			
	Color balance			
	Reset			
	Input signal	Clock	*	
		Tracking	*	
		Horizontal position	*	
		Vertical position	*	
		Overscan	*	0[%], 5[%], 10[%]
Aspect		Auto	LV-7385/LV-7380/LV-7285/LV-7280:Auto, 4:3, 16:9, 15:9, 16:10, Wide zoom, True size	
		Auto	LV-8310/LV-8215: Auto, 4:3, 16:9, 15:9, 16:10, Letterbox, True size	
D.image shift	0	(Not available on LV-8310/LV-8215)		
Setup	General	Auto keystone	On Off, On	
		Keystone adjustment		
		Keystone save	Off Off, On	
		Screen color	Off Off, Whiteboard, Greenboard, Greenboard (Gray), Light yellow, Light green, Light blue, Sky blue, Light rose, Pink	
		Lamp mode	Normal Normal, Quiet	
		Closed caption	Off Off, Caption 1, Caption 2, Caption 3, Caption 4, Text 1, Text 2, Text 3, Text 4	
		Language	English English, Deutsch, Français, Italiano, Español, Svenska, 日本語, Dansk, Português, Čeština, Magyar, Polski, Nederlands, Suomi, Norsk, Türkçe, Русский, العربية, Ελληνικά, 中文, 한국어	
	Menu	Color select	Color Color, Monochrome	
		Input OSD	On Off, On	
		Eco message	Off Off, On	
		Display time	45 sec Manual, 5 sec, 15 sec, 45 sec	
		No signal screen	Blue Blue, Black, Canon logo	
		Filter message	1500(H) Off, 100(H), 200(H), 500(H), 1000(H), 1500(H)	
Installation	Image flip H/V	None None, Rear, Ceiling mounted, Rear, Ceiling mounted		
	Key lock	Off Off, On		
	Password	Off Off, On		
	Communication speed	19200bps 4800bps, 9600bps, 19200bps		

* The asterisk (*) indicates that the default setting varies depending on the signal.

5. Using On-Screen Menu

Setup	Options (1)	Auto PC adjustment		Normal	Off, Normal, Fine	
		Fan mode		Auto	Auto, High, High altitude	
		Input signal select	Computer 1	RGB/ COMPONENT	RGB/COMPONENT, RGB, COMPONENT	
			Computer 2 (Analog)	RGB/ COMPONENT	RGB/COMPONENT, RGB, COMPONENT	
			VIDEO	Auto	Auto, NTSC3.58, NTSC4.43, PAL, PAL-M, PAL-N, PAL60, SECAM	
			S-VIDEO	Auto	Auto, NTSC3.58, NTSC4.43, PAL, PAL-M, PAL-N, PAL60, SECAM	
		WXGA mode		LV-7385/ LV-7380/ LV-7285/ LV-7280: Off LV-8310/ LV-8215: On	Off, On	
	Progressive		On	Off, On		
	Beep		On	Off, On		
	Options (2)	Off timer		Off	Off, 0:30, 1:00, 2:00, 4:00, 8:00, 12:00, 16:00	
		Standby mode		Normal	Normal, Power-saving	
		Direct power on (AC)		Off	Off, On	
		Direct power on (Comp1)		Off	Off, On	
		Power management		Off	Off, 0:05, 0:10, 0:20, 0:30	
Default source select		Last	Last, Auto, Computer 1, Computer 2(Digital), Com- puter 2(Analog), VIDEO, S-VIDEO			
Information	Usage time	Remaining lamp time				
		Lamp counter				
		Filter counter				
		Total carbon savings				
	Input	Input signal				
		Source index				
		Horizontal frequency				
		Vertical frequency				
		Input signal type			RGB, COMPONENT, VIDEO, S-VIDEO, HDTV	
		Video type			NTSC, NTSC3.58, NTSC4.43, PAL, PAL-M, PAL-N, PAL60, SECAM	
		Sync type			Separate sync, Composite sync, Sync on green, Sync on video	
		Sync polarity				
	Scan type			Interlace, Progressive		
	Wired LAN	Projector name				
		IP address				
		Subnet mask				
		Gateway address				
		MAC address				
	Version	Model				
		Serial number				
Firmware version						
Data version						
Reset	Current signal					
	All data					
	Network settings					
	Filter counter					

4 Menu Descriptions & Functions [Input]

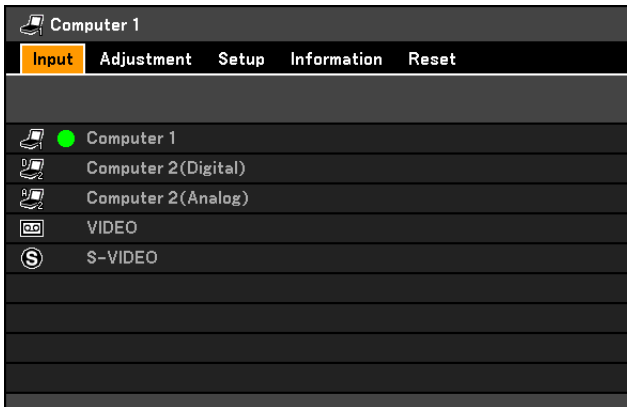

Computer 1

Selects the computer connected to your ANALOG IN-1 input connector.

NOTE:

- When the component input signal is connected to the ANALOG IN-1 connector, select [Computer 1].
 - The projector will determine if the input signal is RGB or component signal.
-

Computer 2 (Digital & Analog)

Selects the computer connected to your DIGITAL IN / ANALOG IN-2 connector.

NOTE: When the component input signal is connected to the DIGITAL IN/ANALOG IN-2 connector, select [Computer 2 (Analog)].

VIDEO

Selects what is connected to your VIDEO input-audio-video equipment.

S-VIDEO

Selects what is connected to your S-VIDEO input-audio-video equipment.

NOTE: A frame may freeze for a brief period of time when a video is played back in fast-forward or fast-rewind with a Video or S-Video source.

5 Menu Descriptions & Functions [Adjustment]

[Image]

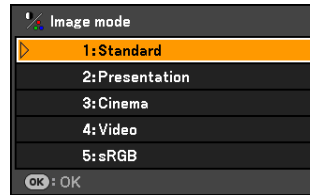
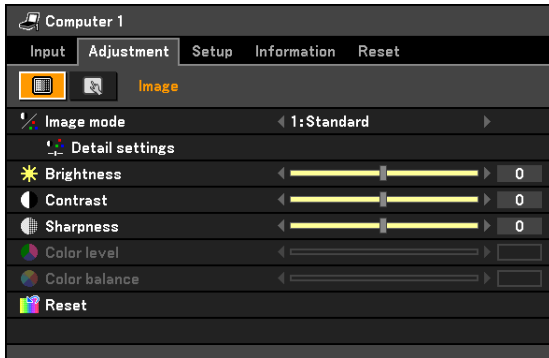

[Image mode]

When selecting user adjustable [Image mode], the submenu will be displayed.

You can customize each gamma or color. To do so, first select [Image mode] and press the OK button, then proceed using the following steps.

[Detail settings]

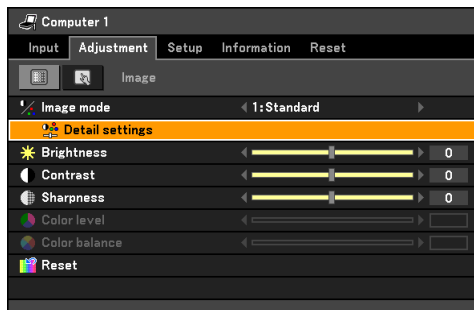

[LV-7385/LV-7380/LV-8310/LV-8215]

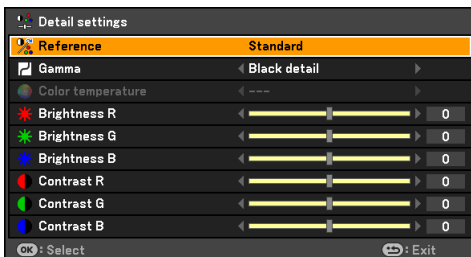

[LV-7285/LV-7280]

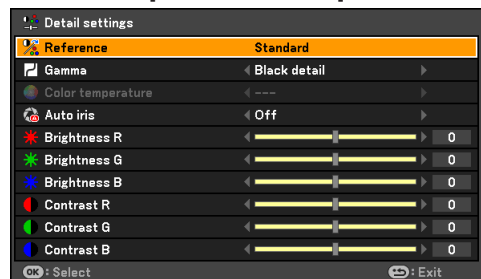

Selecting Reference Setting [Reference]

This option allows you to adjust neutral tint for yellow, cyan or magenta. There are five factory presets optimized for various types of images, you can set user adjustable settings.

- Standard..... Select this to project an image with a similar quality to that of the original image. An image is projected with a high regard for reproduction of white.
- Presentation Select this to project an image with a similar quality to that of the original image. A bright and high-contrast image is projected.
- Cinema Select this to project a moving picture. A picture is projected with a high regard for color tone reproduction.

- Video Select this to project a regular picture such as TV program.
- sRGB Select this when you want to project an image from an sRGBcompatible digital camera. An image is projected in the display mode conforming to the sRGB Standard.

Selecting Gamma Correction Mode [Gamma]

Each mode is recommended for:

- Dynamic Creates a high-contrast picture.
- Natural Natural reproduction of the picture.
- Black detail Emphasizes detail in dark areas of the picture.

Adjusting Color Temperature [Color temperature]

This option allows you to select the color temperature of your choice: 5000K, 6500K, 7300K, 8300K, 9300K, 10500K.

NOTE: When [Standard] or [Presentation] is selected in [Reference], [Color temperature] is not available.

Adjusting Brightness and Contrast [Auto iris] (LV-7285/LV-7280)

This function automatically controls the amount of light in response to an input signal. Reducing amount of light can create a truer black during a dark scene.

-
- NOTE:*
- When [Presentation] or [Cinema] is selected for [Image mode], [Auto iris] will automatically turn on at the factory preset.
 - [Auto iris] cannot be selected in the following conditions:
 - [Lamp mode]: [Quiet]
 - [Fan mode]: [High] or [High altitude]
 - [Closed caption]: all the options other than [Off] when a Video or S-Video input is selected.
-

Adjusting White Balance [Brightness RGB/Contrast RGB]

This allows you to adjust the white balance. Brightness for each color (RGB) is used to adjust the black level of the screen; Contrast for each color (RGB) to adjust the white level of the screen.

Adjusting Brightness, Contrast, Sharpness, Color level and Color balance

You can adjust brightness, contrast, sharpness, color level and color balance.

- Brightness Adjusts the brightness level or the black level of the image.
- Contrast Adjusts the intensity of the image according to the incoming signal (White level of the image).
- Sharpness Controls the detail of the image for Video.
- Color level Increases or decreases the color saturation level.
- Color balance Varies the color level from +/- green to +/-blue. The red level is used as reference.

Input signal	Brightness	Contrast	Sharpness	Color level	Color balance
Computer (RGB Analog)	Yes	Yes	Yes	No	No
Computer (RGB Digital)	Yes	Yes	Yes	No	No
Component	Yes	Yes	Yes	Yes	Yes
Video, S-Video	Yes	Yes	Yes	Yes	Yes

Yes=Adjustable, No=Not adjustable

Reset

The settings and adjustments for [Adjustment] will be returned to the factory settings with the exception of the following; numbers and [Reference] within the [Image mode] screen. The settings and adjustments under [Detail settings] within the [Image mode] screen that are not currently selected will not be reset.

[Input signal]

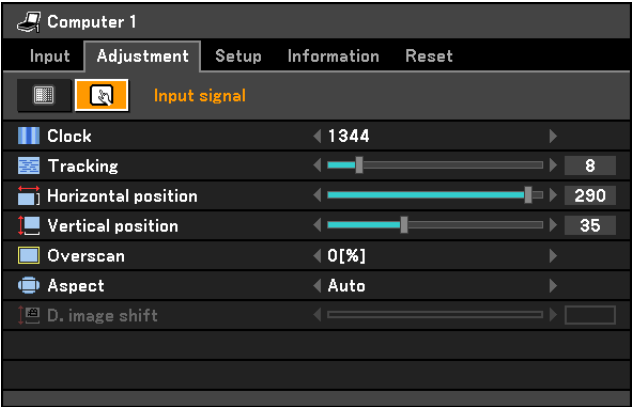

Adjusting Clock and Phase [Clock/Tracking]

This allows you to manually adjust [Clock] and [Tracking].

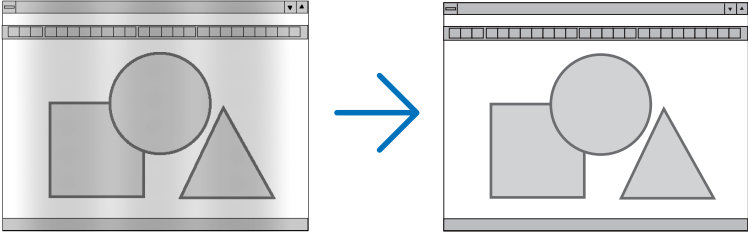

Clock Use this item to fine tune the computer image or to remove any vertical banding that might appear. This function adjusts the clock frequencies that eliminate the horizontal banding in the image. This adjustment may be necessary when you connect your computer for the first time.

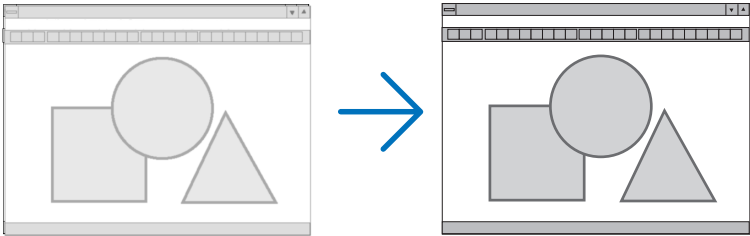

Tracking Use this item to adjust the clock phase or to reduce video noise, dot interference or cross talk. (This is evident when part of your image appears to be shimmering.) Use [Tracking] only after the [Clock] is complete.

Adjusting Horizontal/Vertical Position [Horizontal position/Vertical position]

Adjusts the image location horizontally and vertically.

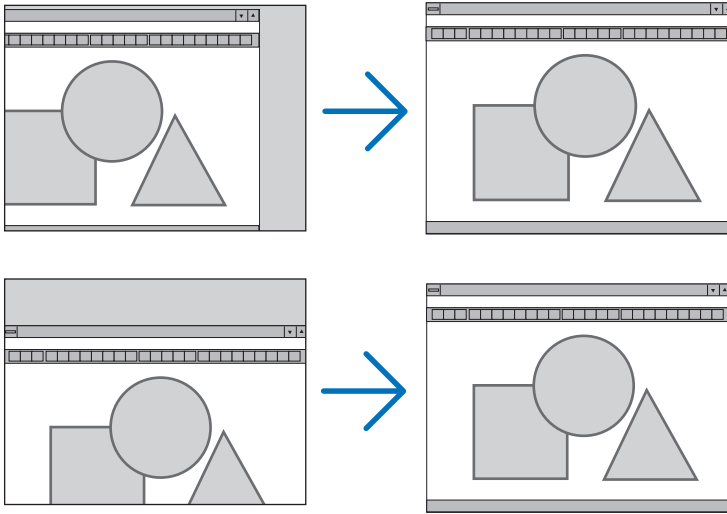

- An image can be distorted during the adjustment of [Clock] and [Tracking]. This is not malfunction.
- The adjustments for [Clock], [Tracking], [Horizontal position], and [Vertical position] will be stored in memory for the current signal. The next time you project the signal with the same resolution, horizontal and vertical frequency, its adjustments will be called up and applied.

To delete adjustments stored in memory, from the menu, you select [Reset] → [Current signal] or [All data] and reset the adjustments.

Selecting Overscan Percentage [Overscan]

Select overscan percentage (0%, 5% and 10%) for signal.

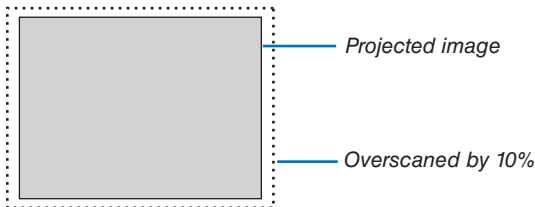
**NOTE:**

- The [0%] cannot be selected when VIDEO and S-VIDEO signals are used.
- [Overscan] is not available when [True size] is selected for [Aspect].

Selecting Aspect Ratio [Aspect]

The term “aspect ratio” refers to the ratio of width to height of a projected image.

The projector automatically determines the incoming signal and displays it in its appropriate aspect ratio.

- This table shows typical resolutions and aspect ratios that most computers support.

Resolution	Aspect Ratio
VGA 640 x 480	4:3
SVGA 800 x 600	4:3
XGA 1024 x 768	4:3
WXGA 1280 x 768	15:9
WXGA 1280 x 800	16:10
WXGA+ 1440 x 900	16:10
SXGA 1280 x 1024	5:4
SXGA+ 1400 x 1050	4:3
UXGA 1600 x 1200	4:3

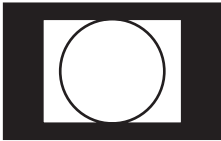
Options	Function
Auto	The projector will automatically determine the incoming signal and display it in its aspect ratio. (→ next page) The projector may erroneously determine the aspect ratio depending on its signal. If this occurs, select the appropriate aspect ratio from the following.
4:3	The image is displayed in 4:3 aspect ratio.
16:9	The image is displayed in 16:9 aspect ratio.
15:9	The image is displayed in 15:9 aspect ratio.
16:10	The image is displayed in 16:10 aspect ratio.
Wide zoom (LV-7385/LV-7380/LV-7285/LV-7280)	The image is stretched left and right. Parts of the displayed image are cropped at the left and right edges and therefore not visible.
Letterbox (LV-8310/LV-8215)	The image of a letterbox signal is stretched equally in the horizontal and vertical directions to fit the screen. Parts of the displayed image are cropped at the top and bottom edges and therefore not visible.
True size	<p>The projector displays the current image in its true resolution when the incoming computer signal has a lower resolution than the projector’s native resolution.</p> <div style="display: flex; justify-content: space-between; align-items: flex-start;"> <div style="width: 60%;"> <p>[Example 1] When the incoming signal with the resolution of 800 x 600 is displayed on the LV-7385/LV-7380/LV-7285/LV-7280:</p> </div> <div style="width: 35%; text-align: center;">  </div> </div> <hr style="width: 60%; margin-left: 0;"/> <div style="display: flex; justify-content: space-between; align-items: flex-start;"> <div style="width: 60%;"> <p>[Example 2] When the incoming signal with the resolution of 800 x 600 is displayed on the LV-8310/LV-8215:</p> </div> <div style="width: 35%; text-align: center;">  </div> </div> <p><i>NOTE:</i></p> <ul style="list-style-type: none"> • When a non-computer signal is displayed, the [True size] is not available. • When a signal with a higher resolution than the projector’s native resolution is displayed, [True size] is not available.

Sample image when the appropriate aspect ratio is automatically determined

LV-7385/LV-7380/LV-7285/LV-7280

[Computer signal]

Aspect ratio of incoming signal	4:3	5:4	16:9	15:9	16:10
Sample image when the appropriate aspect ratio is automatically determined					

[Video signal]

Aspect ratio of incoming signal	4:3	Letterbox	Squeeze
Sample image when the aspect ratio is automatically determined			
			<i>NOTE: To display a squeezed signal properly, select [16:9] or [Wide zoom].</i>

LV-8310/LV-8215

[Computer signal]

Aspect ratio of incoming signal	4:3	5:4	16:9	15:9	16:10
Sample image when the appropriate aspect ratio is automatically determined					

[Video signal]

Aspect ratio of incoming signal	4:3	Letterbox	Squeeze
Sample image when the aspect ratio is automatically determined			
		<i>NOTE: To display a letterbox signal properly, select [Letterbox].</i>	<i>NOTE: To display a squeezed signal properly, select [16:9].</i>

TIP:

- Image position can be adjusted vertically using [D.image shift] when the [16:9], [15:9], or [16:10] aspect ratios are selected. (→ [next page](#))
- The term "letterbox" refers to a more landscape-oriented image when compared to a 4:3 image, which is the standard aspect ratio for a vide source.
The letterbox signal has aspect ratios with the vista size "1.85:1" or cinema scope size "2.35:1" for movie film.
- The term "squeeze" refers to the compressed image of which aspect ratio is converted from 16:9 to 4:3.

Adjusting the Vertical Position of Image [D.image shift] (not available on LV-8310/LV-8215)

When [16:9], [15:9], or [16:10] is selected in [Aspect], the image is displayed with black borders on the top and bottom.

You can adjust the vertical position from the top to the bottom of the black area.

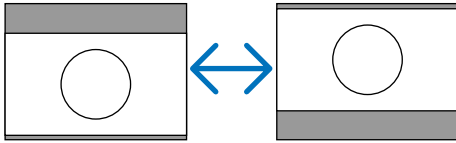

6 Menu Descriptions & Functions [Setup]

[General]

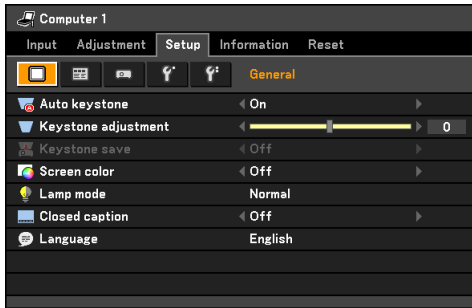

Enabling Auto Keystone [Auto keystone]

This feature allows the projector to detect its tilt and correct vertical distortion automatically. To turn off the Auto Keystone feature, select [Off].

NOTE: When [Auto keystone] is set to [On], [Keystone save] is not available. Next time you turn on the power, the Auto keystone function will work and the data stored with [Keystone save] will be invalid.

Correcting Vertical Keystone Distortion Manually [Keystone adjustment]

You can correct vertical distortion manually.

Saving Vertical Keystone Correction [Keystone save]

This option enables you to save your current keystone settings.

- Off..... Does not save current keystone correction settings
- On..... Saves current keystone correction settings

Saving your change once affects all sources. The changes are saved when the projector is off.

Selecting Wall Color Correction Mode [Screen color]

This function allows for quick adaptive color correction in applications where the screen material is not white. The following 10 options are available: Off, Whiteboard, Greenboard, Greenboard (Gray), Light yellow, Light green, Light blue, Sky blue, Light rose and Pink.

NOTE: When [Whiteboard] is selected, the light output becomes low.

Selecting Lamp Mode [Lamp mode]

Selecting [Quiet] for Lamp mode will help you to reduce CO₂ emissions from the projector.

(Amount of CO₂ emission reduction is calculated based on power consumption)

This feature enables you to select two brightness modes of the lamp: Normal and Quiet modes. The lamp life can be extended by using the Quiet mode.

Setting Closed Caption [Closed caption]

This option sets several closed caption modes that allow text to be superimposed on the projected image of Video or S-Video.

Off This exits the closed caption mode.

Caption 1-4..... Text is superimposed.

Text 1-4 Text is displayed.

NOTE:

The closed caption is not available under the following conditions:

- when messages or menus are displayed.
 - when an image is magnified, frozen, or muted.
-

Selecting Menu Language [Language]

You can choose one of 21 languages for the on-screen menu.

[Menu]

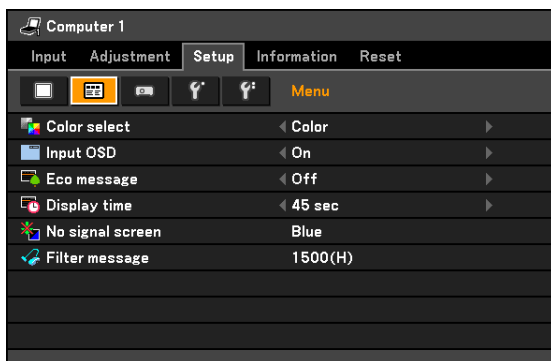

Selecting Menu Color [Color select]

You can choose between two color modes for menu color: Color and Monochrome.

Turning On / Off Input Display [Input OSD]

This option turns on or off input name display such as Computer 1, Computer 2(Digital), Computer 2(Analog), VIDEO, S-VIDEO and No Input to be displayed on the top right of the screen.

Turning On / Off Eco Message [Eco message]

This option turns on or off the following messages when the projector is turned on.

The Eco Message prompts the user to save energy. When [Normal] is selected for [Lamp mode], you will get a message to prompt you to select [Quiet] for [Lamp mode].

When [Quiet] is selected for [Lamp mode]

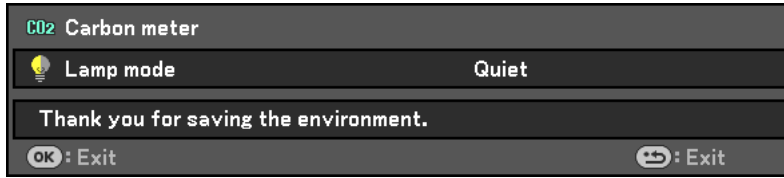

To close the message, press the OK or the BACK button. The message will disappear if no button operation is done for 30 seconds.

When [Normal] is selected for [Lamp mode]

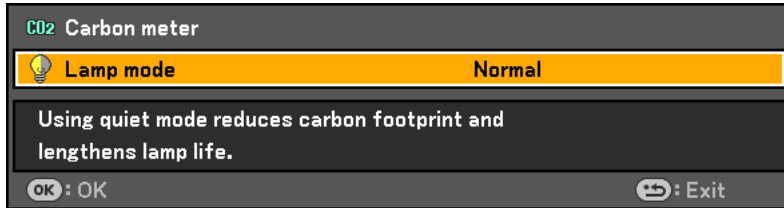

Pressing the OK button will display the [Lamp mode] screen. (→ page 38)
To close the message, press the BACK button.

Selecting Menu Display Time [Display time]

This option allows you to select how long the projector waits after the last touch of a button to turn off the menu. The preset choices are Manual, 5 sec, 15 sec, and 45 sec.

Selecting a Color for Background [No signal screen]

Use this feature to display a blue, black screen or the Canon logo screen when no signal is available.

Selecting Interval Time for Filter Message [Filter message]

The projector has a feature that informs you of the timing for cleaning the filters.

This item allows you to select the time preference between displaying the message for cleaning the filters. Clean the filter when you get the message "Please clean filter." See page 69.

Five options are available: Off, 100(H), 200(H), 500(H), 1000(H), 1500(H)

The default setting is 1500(H). Change the interval time depending on the degree of dust and dirt on the filters.

NOTE:

- 1) The message for lamp replacement and filter cleaning will be displayed under the following conditions:
 - one minute after the projector has been powered on.
 - when the POWER button on the projector cabinet or on the remote control is pressed.To cancel the message, press any button on the projector cabinet or the remote control.
 - 2) Your setting will not be affected even when [Reset] is done from the menu.
-

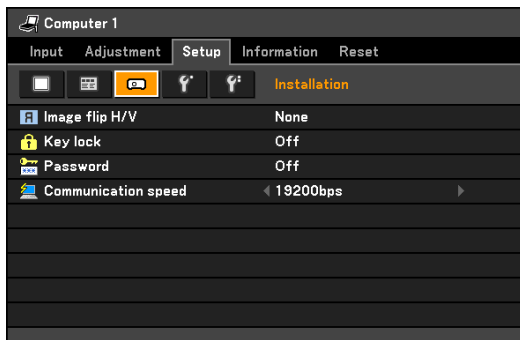
[Installation]**Selecting Projector Orientation [Image flip H/V]**

This sets your image for your type of projection application. The options are: front projection, rear projection, ceiling mounted projection and rear ceiling mounted projection.

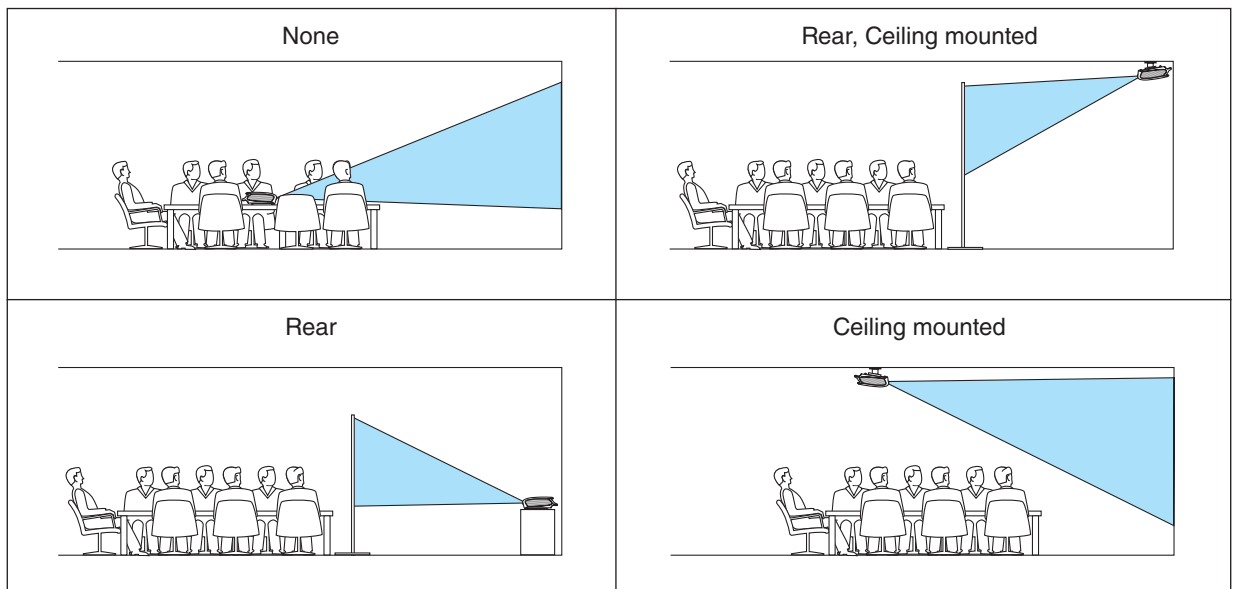
**Disabling the Cabinet Buttons [Key lock]**

This option turns on or off the Key Lock function for cabinet buttons.

NOTE:

- The Key lock setting will not affect the remote control or PC control functions.
- When the cabinet buttons are disabled, pressing and holding the BACK button on the projector cabinet for about 10 seconds will change the setting to enable.

TIP: The Key lock icon (🔒) will be displayed at the top right of the menu when Key lock is enabled.

Enabling Password [Password]

This feature turns on or off the Password function.

Unless the correct password is entered, the projector cannot project an image. See page 40.

NOTE: Your setting will not be affected even when [Reset] is done from the menu.

Selecting Communication Speed [Communication speed]

This feature sets the baud rate of the SERVICE PORT (D-Sub 9 Pin). It supports data rates from 4800 to 19200 bps.

The default is 19200 bps.

Select the appropriate baud rate for your equipment to be connected (depending on the equipment, a lower baud rate may be recommended for long cable runs).

NOTE: Your selected communication speed will not be affected even when [Reset] is done from the menu.

[Options (1)]

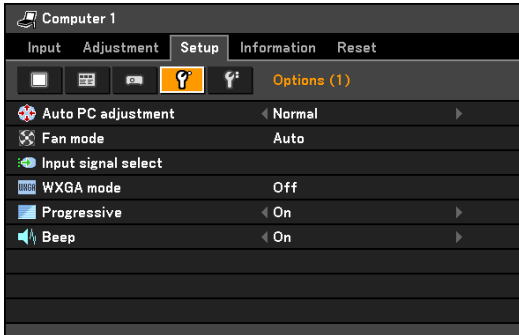

Setting Auto Adjust [Auto PC adjustment]

Selecting [Normal] or [Fine] will automatically execute Auto PC adjustment function at the time of signal switching. This feature sets the Auto PC adjust mode so that the analog RGB image can be automatically or manually adjusted for noise and stability. You can automatically make adjustment in two ways: Normal and Fine

- Off..... The RGB image will not be automatically adjusted.
You can manually optimize the RGB image.
- Normal..... Default setting. The RGB image will be automatically adjusted. Normally select this option.
- Fine..... Select this option if fine adjustment is needed. It takes more time to switch to the source than when [Normal] is selected.

Enabling Fan Speed Mode [Fan mode]

This option allows you to select three modes for fan speed: Auto, High, and High altitude.

- Auto..... The built-in fans automatically run at a variable speed according to the internal temperature.
- High..... The built-in fans run at a fixed high speed.
- High altitude The built-in fans run at a high speed. Select this option when using the projector in places at 5500 ft./1600 m or higher.

When you wish to cool down the temperature inside the projector quickly, select [High].

NOTE: It is recommended that you select High speed mode if you continue to use the projector for consecutive days.

NOTE:

- It is recommended that you select High speed mode if you use the projector non-stop for consecutive days.
 - Be sure to select [High altitude] when using the projector at altitudes approximately 5500 feet/1600 meters or higher.
 - Using the projector at altitudes approximately 5500 feet/1600 meters or higher without setting to [High altitude] can cause the projector to overheat and the protector could shut down. Furthermore, the projector could not turn on due to the increased temperature of the lamp after power off. If these happen, wait a couple minutes and turn on the projector.
 - Using the projector at altitudes less than approximately 5500 feet/1600 meters and setting to [High altitude] can cause the lamp to overcool, causing the image to flicker.
 - Your Fan mode setting will not be affected even when [Reset] is done from the menu.
-

Selecting Signal Format [Input signal select]

[Computer 1], [Computer 2 (Analog)]

Allows you to choose [Computer 1] or [Computer 2 (Analog)] for an RGB source such as a computer, or [COMPONENT] for a component video source such as a DVD player. Normally select [RGB/COMPONENT] and the projector automatically detects a component signal. However there may be some component signals that the projector is unable to detect. If this is the case, select [COMPONENT].

[VIDEO & S-VIDEO System Select]

This feature enables you to select composite video standards automatically or manually.

Normally select [Auto] and the projector will automatically detect the video standard.

In the case where the projector has difficulty detecting the video standard, select the appropriate video standard from the menu.

This must be done for VIDEO and S-VIDEO respectively.

Enabling or Disabling WXGA Mode [WXGA mode]

Selecting [On] will give priority to a WXGA (1280 x 768) signal in recognizing an input signal.

When [WXGA mode] is set to [On], an XGA (1024 x 768) signal may not be recognized on LV-7385, LV-7380, LV-7285 or LV-7280. In this case, select [Off].

Enabling the deinterlace [Progressive]

Turns on or off the deinterlace function for a telecine signal.

Off Select this option if there is any jitter or artifacts in video.

On..... Default standard setting.

NOTE: This feature is not available for RGB and HDTV signals.

Enabling Key Sound and Error Sound [Beep]

This feature turns on or off the keypad sound or alarm when a button on the cabinet and the remote control is pressed or an error occurs.

NOTE: The [Beep] sound volume cannot be adjusted. The [Beep] sound cannot be muted by using the BLANK button. To turn off the [Beep] sound, select [Off] for [Beep].

[Options (2)]

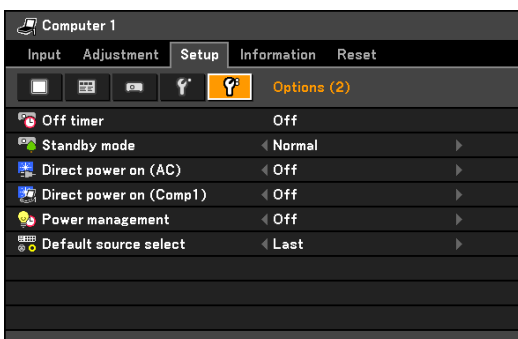

Setting Off Timer [Off timer]

You can use the Off Timer feature to turn off the projector (standby mode) automatically at a preset time.

Eight preset times can be selected: Off, 0:30, 1:00, 2:00, 4:00, 8:00, 12:00 and 16:00.

The remaining count-down time will be shown at the top right of the menu when the [Off timer] is preset.

The POWER indicator blinks green in cycle of 2.5 seconds on and 0.5 second off when [Off timer] is preset.

When the off timer remaining time reaches 3 minutes, a message will be displayed to that effect.

Selecting Power-saving in [Standby mode]

The projector has two standby modes: [Normal] and [Power-saving].

The Power-saving mode is the mode that allows you to put the projector in the power-saving condition which consumes less power than the Normal mode. The projector is preset for Normal mode at the factory.

Normal POWER indicator: Orange light/STATUS indicator: Green light

Power-saving POWER indicator: Red light/STATUS indicator: Off

The following connectors, buttons or functions will not work during this mode.

- SERVICE PORT, MONITOR OUT connector, and AUDIO OUT connector
- LAN, Mail Alert, Direct power on (Comp1) functions
- Buttons other than POWER button on the cabinet
- Buttons other than POWER button on the remote control

NOTE: Your setting will not be affected even when [Reset] is done from the menu.

Enabling Direct Power ON [Direct power on (AC)]

Turns the projector on automatically when AC power is supplied. This eliminates the need to always use the POWER button on the remote control or projector cabinet.

Turning On the Projector By Applying Computer Signal [Direct power on (Comp1)]

When the projector is in Standby mode, applying a computer signal from a computer connected to the ANALOG IN-1 input will power on the projector and simultaneously project the computer's image.

This functionality eliminates the need to always use the POWER button on the remote control or the projector cabinet to power on the projector.

To use this function, first connect a computer to the projector and the projector to an active AC input.

NOTE:

- *Disconnecting a computer signal from the computer will not power off the projector. We recommend using this function in combination of the Power management function.*
 - *This function will not be available under the following conditions:*
 - *when a component signal is applied to the ANALOG IN-1 connector*
 - *when a Sync on Green RGB signal or composite sync signal is applied*
 - *Once [Direct power on (Comp1)] is turned on, [Power-saving] mode cannot be selected. [Power-saving] mode will not take effect regardless of whether it is selected for [Standby mode].*
 - *To enable the Direct power on (Comp 1) after turning off the projector, wait 3 seconds and input an analog RGB signal. If an analog RGB signal is still present when the projector is turned off, the Direct power on (Comp 1) will not work and the projector remains in standby mode.*
-

Enabling Power Management [Power management]

When this option is selected you can enable the projector to automatically turn off (at the selected time: 5 min., 10 min., 20 min., 30 min.) if there is no operation with no signal received by any input. When the remaining time reaches 3 minutes, a message will be displayed to that effect.

Selecting Default Source [Default source select]

You can set the projector to default to any one of its inputs each time the projector is turned on.

- Last Sets the projector to default to the previous or last active input each time the projector is turned on.
- Auto Searches for an active source in order of Computer 1 → Computer 2 (Digital) → Computer 2 (Analog) → VIDEO → S-VIDEO → Computer 1 and displays the first found source.
- Computer 1 Displays the RGB source from the Computer 1 Input [ANALOG IN-1] connector every time the projector is started up.
- Computer 2 (Digital) ... Displays the DVI digital source from the Computer 2 Input [DIGITAL IN/ANALOG IN-2] (Digital) connector every time the projector is started up.
- Computer 2 (Analog) .. Displays the RGB analog source from the Computer 2 Input [DIGITAL IN/ANALOG IN-2] (Analog) connector every time the projector is started up.
- VIDEO Displays the Video source from the VIDEO IN connector every time the projector is started up.
- S-VIDEO Displays the Video source from the S-VIDEO IN connector every time the projector is started up.

7 Menu Descriptions & Functions [Information]

Displays the status of the lamp / filter, the current signal, the wired LAN, and the version. This item has four pages. The information included is as follows:

NOTE: Pressing the INFO button on the remote control will show the [Information] menu items.

[Usage time]

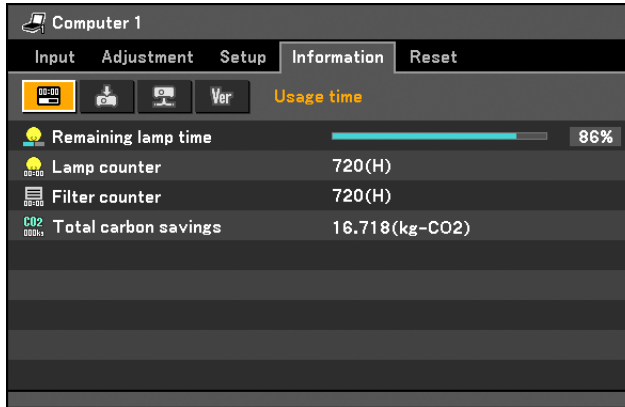

[Remaining lamp time] (%)
[Filter counter] (H)

[Lamp counter] (H)
[Total carbon savings](kg-CO2)

Remaining Lamp Time/Lamp Counter

The projector has the Quiet mode. The lamp life varies depending on two modes: quiet mode and normal mode. Selecting the Quiet mode allows you to reduce power consumption.

The [Remaining lamp time] shows the percentage of remaining bulb life. The [Lamp counter] shows the amount of lamp usage (hours).

- When the remaining lamp time reaches 0%, the “Replace with the new lamp.” message will be displayed. Replace with the new lamp.
See page 71 for lamp replacement.
- The message for lamp replacement will be displayed under the following conditions:
 - one minute after the projector has been powered on.
 - when the POWER button on the projector cabinet or on the remote control is pressed.
 To cancel the message, press any button on the projector cabinet or the remote control.

- When the remaining lamp time reaches 0%, the Remaining lamp time bar indicator changes from 0% to 100(H) in red and starts counting down.
When the remaining lamp time reaches 0 hours, the projector will not turn on.

Lamp mode	Lamp counter		Lamp remaining time
	[Normal] only	[Quiet] only	
Factory setting	0 hours		100%
Lamp life	4000 hours (mini.)	5000 hours (max.)	0%

• Total Carbon Savings

This displays the estimated carbon saving information in kg. The carbon footprint factor in the carbon saving calculation is based on the OECD (2008 Edition).

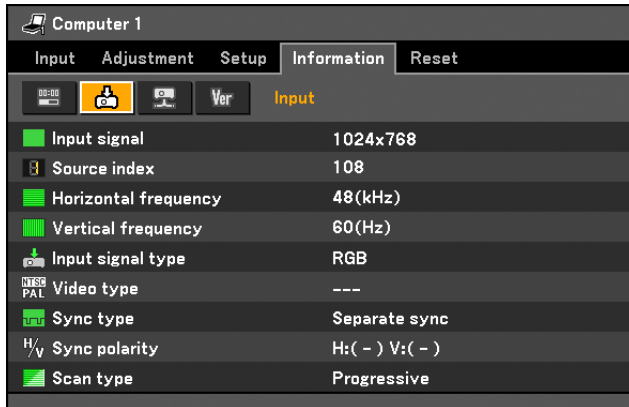
[Input]

[Input signal] [Source index] [Horizontal frequency]
 [Vertical frequency] [Input signal type] [Video type]
 [Sync type] [Sync polarity] [Scan type]

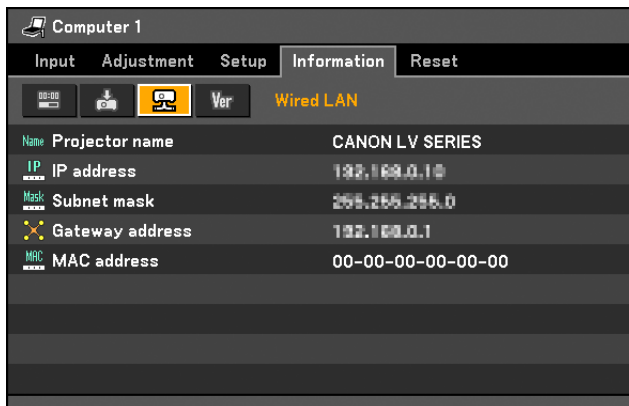
[Wired LAN]

[Projector name] [IP address] [Subnet mask]
 [Gateway address] [MAC address]

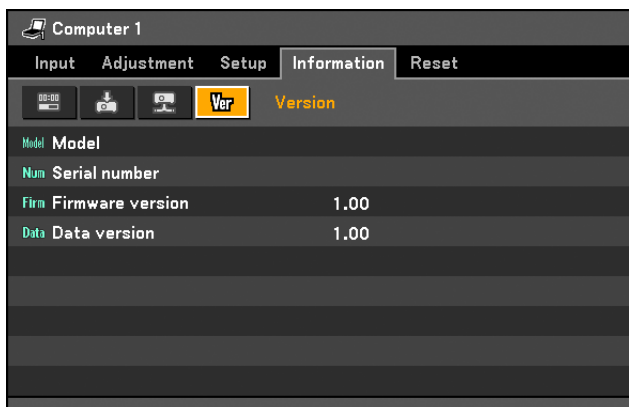
[Version]

[Model] [Serial number] [Firmware version]
 [Data version]

8 Menu Descriptions & Functions [Reset]

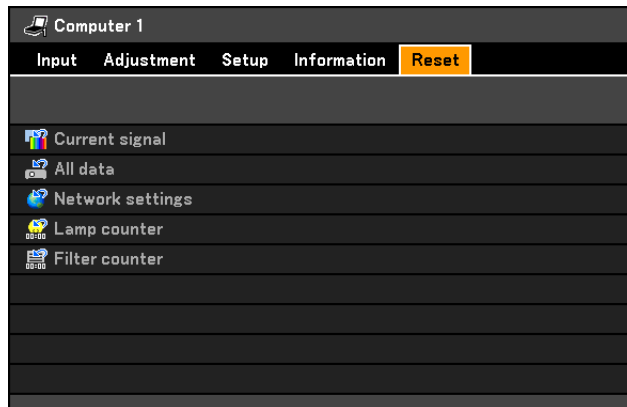

Resetting settings and adjustments [Reset]

The Reset feature allows you to change adjustments and settings to the factory preset.

Clearing adjustments and settings for the current signal [Current signal]

Resets the adjustments for the current signal to the factory preset levels.

The items that can be reset are: [Image mode], [Brightness], [Contrast], [Sharpness], [Color level], [Color balance], [Aspect], [Horizontal position], [Vertical position], [Clock], [Tracking], and [Overscan].

Clearing all the adjustments and settings [All data]

Reset all the adjustments and settings for all the signals to the factory preset.

All items can be reset **EXCEPT** [Language], [No signal screen], [Filter message], [Password], [Communication speed], [Standby mode], [Fan mode], [Remaining lamp time], [Lamp counter], [Filter counter], [Total carbon savings], and [Network settings].

Clearing Networking Settings [Network settings]

Returns [DHCP], [IP ADDRESS], [SUBNET MASK], and [GATEWAY] to the default settings.

Clearing Lamp Hour Meter [Lamp counter]

Resets the lamp clock back to zero. Selecting this option displays submenu for a confirmation. Select [Yes] and press the OK button.

NOTE: Elapsed time of the lamp use will not be affected even when [Reset] is done from the menu.

NOTE: The projector will turn off and go into standby mode when you continue to use the projector for another 100 hours after the lamp has reached the end of its life. If this happens, press the INFO button on the remote control for 10 seconds to reset the lamp clock back to zero. Do this only after replacing the lamp.

NOTE: Resetting the lamp counter before or without replacing the lamp will not display the exact lamp usage hours. Using the lamp beyond its service life may cause the lamp to break. Be sure to reset the lamp counter after replacing the lamp.

Clearing the Filter Usage Hours [Filter counter]

Resets the filter usage back to zero. Selecting this option displays submenu for a confirmation. Select [Yes] and press the OK button.

NOTE: Elapsed time of the filter use will not be affected even when [Reset] is done from the menu.

6. Maintenance

This section describes the simple maintenance procedures you should follow to clean the filter and replace the lamp.

1 Cleaning or Replacing the Filter

The air-filter keeps dust and dirt from getting inside the projector and should be frequently cleaned. If the filter is dirty or clogged, your projector may overheat.

NOTE: The message for filter cleaning will be displayed for one minute after the projector is turned on or off. To cancel the message, press any button on the projector cabinet or the remote control.

CAUTION

- Turn off the projector, turn off the main power switch and unplug the projector before replacing the filter.
- Only clean the outside of the filter cover with a vacuum cleaner.
- Do not attempt to operate the projector without the filter cover.

To clean the air-filter:

Vacuum the filter-through the filter cover.

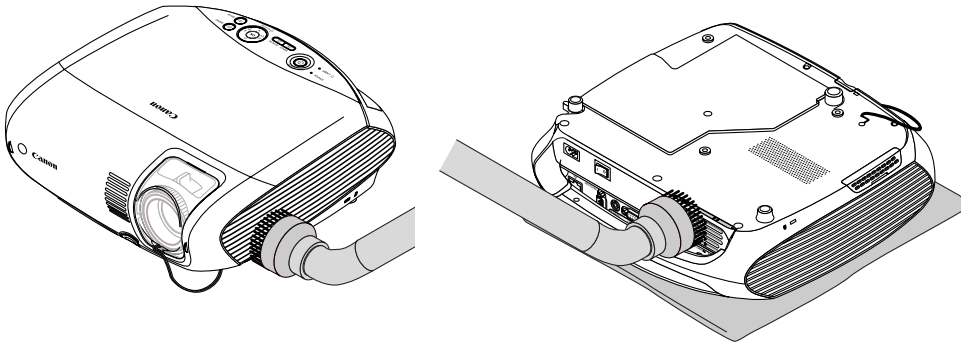

NOTE: When turning over the projector, slowly place it on a soft cloth so as not to scratch the cabinet.

To replace the filter:

1. Remove the filter cover (2 locations) by pushing up on the tab of the cover.

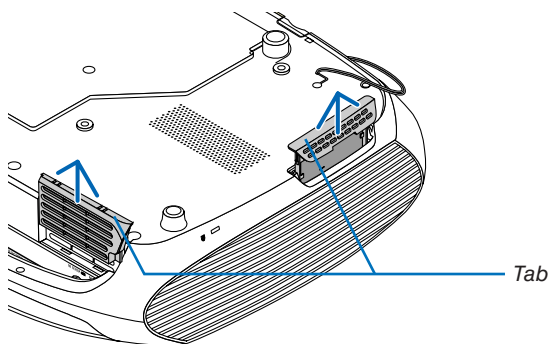

2. Replace two filters.

- (1) Gently peel off the filter and clean the filter cover.
- (2) Attach the new filter to the filter cover.

The air filter comes in two types. These two filters cannot be interchanged.

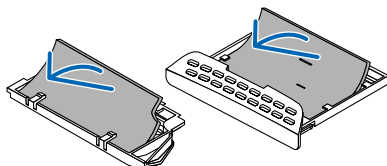

3. Reinstall the new filter cover (2 locations).

- Insert the filter cover until you feel click.

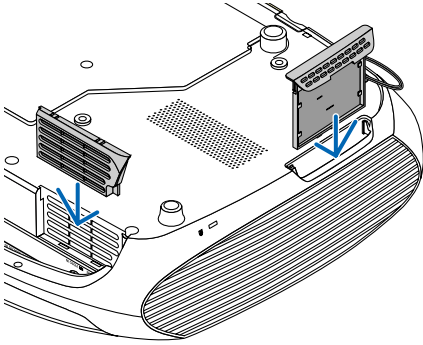
**4. Clear the filter hours used.**

To reset the filter usage time, from the menu, select [Reset] → [Filter counter].
(See page 68 for resetting the filter usage time.)

NOTE: Do not wash the filter with soap and water. Soap and water will damage the filter membrane. Before replacing the filter, remove dust and dirt from the projector cabinet. Keep out dust and dirt during filter replacement.

NOTE: When you replace the lamp, it is also wise to replace the filter. The filter comes in the same package with your replacement lamp.

② Cleaning the Cabinet and the Lens

1. Turn off the projector before cleaning.
2. Clean the cabinet periodically with a damp cloth. If heavily soiled, use a mild detergent. Never use strong detergents or solvents such as alcohol or thinner.
3. Use a blower or lens paper to clean the lens, and be careful not to scratch or mar the lens.

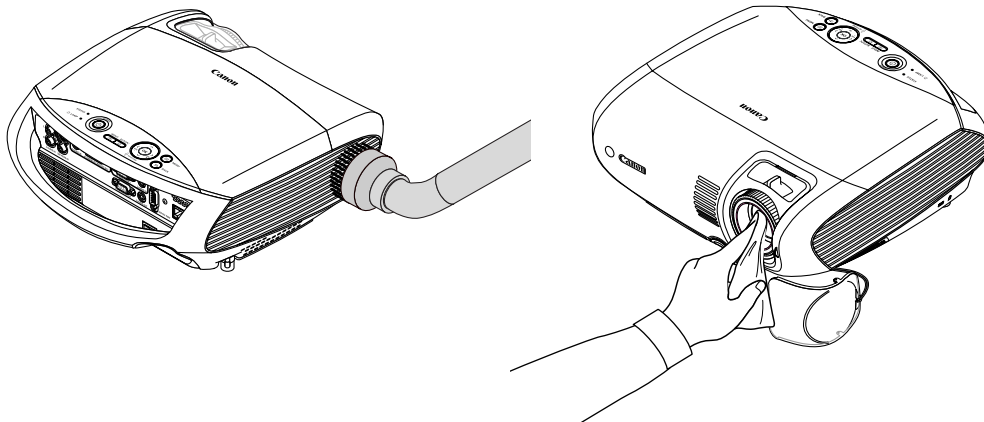

3 Replacing the Lamp

When the lamp reaches the end of its life, the LAMP indicator in the cabinet will blink red and the message “Replace with the new lamp.”* will appear. Even though the lamp may still be working, replace the lamp to maintain the optimal projector performance. After replacing the lamp, be sure to clear the lamp hour meter. See page 68.

CAUTION

- DO NOT TOUCH THE LAMP immediately after it has been used. It will be extremely hot. Turn the projector off, turn off the main power switch and then disconnect the power cord. Allow at least one hour for the lamp to cool before handling.
- DO NOT REMOVE ANY SCREWS except two lamp housing screws. You could receive an electric shock.
- Do not break the glass on the lamp housing.

Keep finger prints off the glass surface on the lamp housing. Leaving finger prints on the glass surface might cause an unwanted shadow and poor picture quality.

- The projector will turn off and go into standby mode when you continue to use the projector for another 100 hours after the lamp has reached the end of its life. If this happens, be sure to replace the lamp. If you continue to use the lamp after the lamp reaches the end of its life, the lamp bulb may shatter, and pieces of glass may be scattered in the lamp case. Do not touch them as the pieces of glass may cause injury. If this happens, contact your dealer for lamp replacement.

**NOTE: The message [Replace with the new lamp.] will be displayed under the following conditions:*

- for one minute after the projector has been powered on
- when the  (POWER) button on the projector cabinet or on the remote control is pressed

To turn off the message, press any button on the projector cabinet or the remote control.

To replace the lamp:

Optional lamp and tools needed for replacement:

- Replacement lamp

Lamp	Projector
LV-LP31	LV-7385/LV-8310/LV-8215
LV-LP32	LV-7380/LV-7285/LV-7280

- Phillips screwdriver and flathead screwdriver

1. Remove the lamp cover.

There are two locks on the left and right sides.

- (1) Use the tip of the flathead screwdriver to push and release one lock.
- (2) Do this for the other lock.
- (3) Slowly pull the lamp cover in the direction of the arrow and lift it.

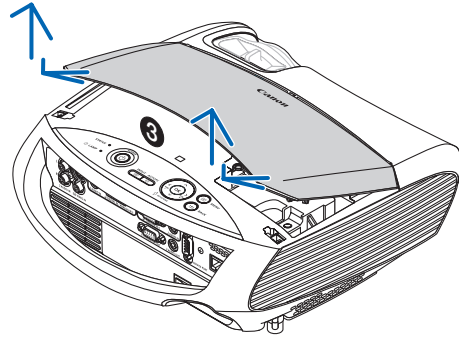
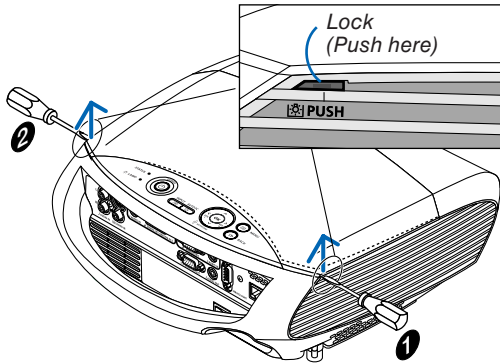
**2. Remove the lamp.**

- (1) Loosen the two screws securing the lamp until the phillips screwdriver goes into a freewheeling condition.
 - The two screws are not removable.
 - There is an interlock on this case to prevent the risk of electrical shock. Do not attempt to circumvent this interlock.
- (2) Remove the lamp by holding it.

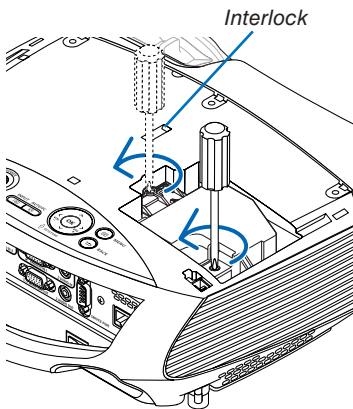
**⚠ CAUTION:**

Make sure that the lamp is cool enough to before removing it.

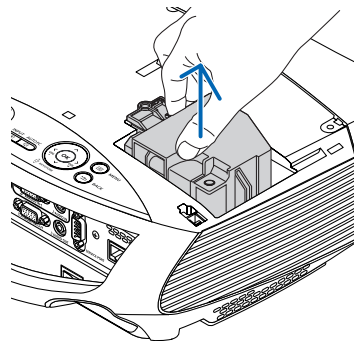

3. Install a new lamp.

(1) Insert a new lamp until the lamp is plugged into the socket.

CAUTION

Do not use a lamp other than the replacement lamp LV-LP31 (LV-7385/LV-8310/LV-8215) and LV-LP32 (LV-7380/LV-7285/LV-7280). Order this from your dealer.

(2) Push the top center of the lamp to secure it.

(3) Secure it in place with the two screws.

- Be sure to tighten the screws.

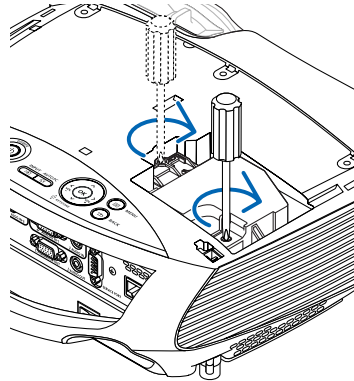
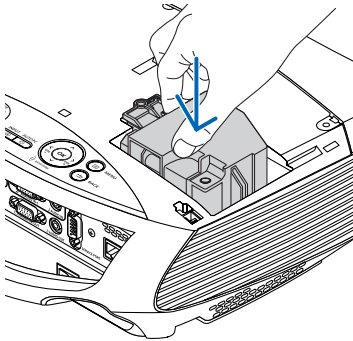
**4. Reattach the lamp cover.**

(1) Insert three tabs into three grooves.

(2) Push down both ends of the lamp cover until you feel click.

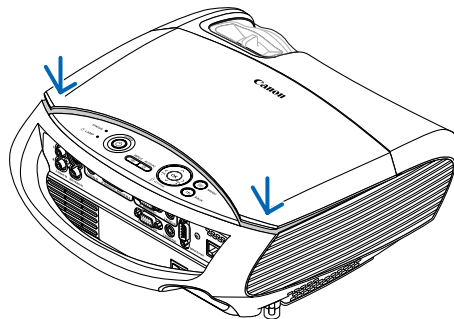
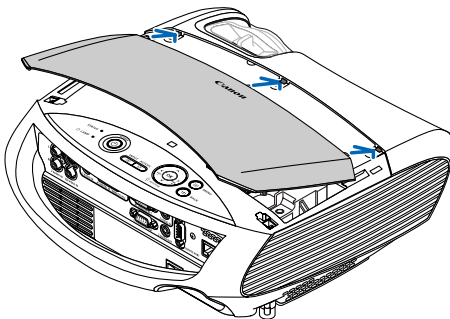

5. Connect the supplied power cord, turn on the Main Power switch and turn on the projector.

6. Finally, select the menu → [Reset] → [Lamp counter] to reset the lamp usage hours.

NOTE: When you continue to use the projector for another 100 hours after the lamp has reached the end of its life, the projector cannot turn on and the menu is not displayed.

If this happens, press the INFO button on the remote control for 10 seconds to reset the lamp clock back to zero.

When the lamp time clock is reset to zero, the LAMP indicator goes out.

7. Appendix

1 Troubleshooting

This section helps you resolve problems you may encounter while setting up or using the projector.

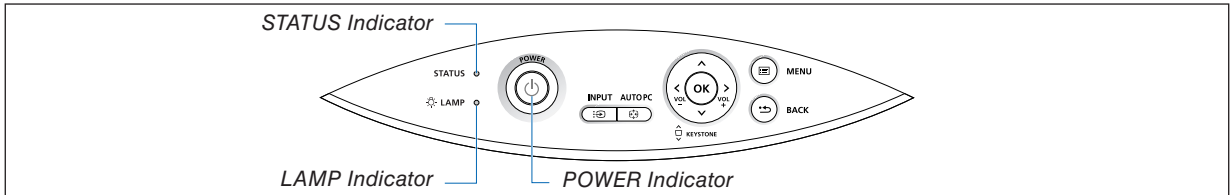

Indicator Messages

POWER Indicator

Indicator Condition		Projector Condition	Note
Off		The main power is off	–
Blinking light	Green	0.5 sec On, 0.5 sec Off	The projector is getting ready to turn on.
		2.5 sec On, 0.5 sec Off	Off Timer is enabled.
Steady light	Green	The projector is turned on.	–
	Orange	[Normal] is selected for [Standby mode]	–
	Red	[Power-saving] is selected for [Standby mode]	–

STATUS Indicator

Indicator Condition		Projector Condition	Note
Off		Normal	–
Blinking light	Red	1 cycle (0.5 sec On, 2.5 sec Off)	Lamp cover error or lamp housing error Replace the lamp cover or lamp correctly. See page 73.
		2 cycle (0.5 sec On, 0.5 sec Off)	Temperature error The projector is overheated. Move the projector to a cooler location.
		3 cycle (0.5 sec On, 0.5 sec Off)	Power error Power unit is not working properly. Contact your dealer
		4 cycle (0.5 sec On, 0.5 sec Off)	Fan error Fans will not work correctly.
		6 cycle (0.5 sec On, 0.5 sec Off)	Lamp error Lamp fails to light. Wait a full minute and then turn on again.
		9 cycle (0.5 sec On, 0.5 sec Off)	[Auto iris] error The Auto iris function is not working properly. (LV-7285 and LV-7280). Contact your dealer.
	Green	Re-firing the lamp The projector is re-firing. Wait for a moment.	
Steady light	Green	Standby([Normal] for [Standby mode])	–
	Orange	Key lock is on. You have pressed cabinet button when Key lock is on. See page 62.	

LAMP Indicator

Indicator Condition		Projector Condition	Note
Off		Normal	–
Blinking light	Red	Lamp has reached its end of life. Lamp replacement message will be displayed.	Replace the lamp.
Steady light	Red	Lamp has been used beyond its limit. The projector will not turn on until the lamp is replaced.	Replace the lamp.
	Green*	Lamp mode is set to Quiet mode.	–

* This indicator lights green for about 90 seconds immediately after the projector is powered on.

If a temperature error occurs

If the temperature inside the projector rises too high, the over-temperature protector will automatically turn off the lamp with the STATUS indicator blinking (2-cycle On and Off.)

Should this happen, do the following:

- Turn off the main power and unplug the AC power cord.
- Move the projector to a cooler location if the room where you are presenting is particularly too warm.
- Clean the ventilation holes if they are clogged with dust.
- Wait about 60 minutes until the inside of the projector becomes cool enough.

Common Problems & Solutions (→ "POWER/STATUS/LAMP Indicator" on page 74.)

Problem	Check These Items
Does not turn on	<ul style="list-style-type: none"> • Check that the power cord is plugged in and that the power button on the projector cabinet or the remote control is on. See pages 23 and 24. • Ensure that the lamp cover or the lamp is installed correctly. See page 73. • Check to see if the projector has overheated. If there is insufficient ventilation around the projector or if the room where you are presenting is particularly warm, move the projector to a cooler location. • Check to see if you continue to use the projector for another 100 hours after the lamp has reached the end of its life. If so, replace the lamp. • The lamp may fail to light. Wait a full minute and then turn on the power again. • The lamp has reached the end of its usable life. Replace the lamp. • Set [Fan mode] to [High altitude] when using the projector at altitudes approximately 5500 feet/1600 meters or higher. Using the projector at altitudes approximately 5500 feet/1600 meters or higher without setting to [High altitude] can cause the projector to overheat and the projector could shut down. Also the projector could not turn on due to the increased temperature of the lamp after power off. If these happen, wait a couple minutes and turn on the projector. See page 63. • Also when the lamp is turned off, the projector internal temperature is hot. If the power is turned on before the projector has cooled down, the fan will run a short time before the lamp will turn on. • If any of the above is not the cause of the problem, turn off the main power and disconnect the power cord. After allowing 5 minutes, plug the power cord and turn on the main power.
Will shut down	<ul style="list-style-type: none"> • Ensure that the Off timer or Power management is off. See page 64, 65.
No picture	<ul style="list-style-type: none"> • Use the INPUT button to select your source. See page 26. • Ensure your cables are connected properly. • Use menus to adjust the brightness and contrast. See page 53. • Remove the lens cover. • Reset the settings or adjustments to factory preset levels using the [Reset] in the Menu. See page 68. • Enter your registered Password if the Password function is enabled. See page 40. • When using with a notebook PC, be sure to connect between the projector and the notebook PC before turning on the power to the notebook PC. In most cases signal cannot be output from RGB output unless the notebook PC is turned on after connecting with the projector. <ul style="list-style-type: none"> * If the screen goes blank while using your remote control, it may be the result of the computer's screen-saver or power management software. • See also the next page.
Picture suddenly becomes dark	<ul style="list-style-type: none"> • Check if the projector is in the Forced cooling operation because of too high ambient temperature. If this is the case, lower the internal temperature of the projector by selecting [High] for [Fan mode]. See page 63.
Color tone or Color balance is unusual	<ul style="list-style-type: none"> • Check if an appropriate color is selected in [Screen color]. If so, select an appropriate option. See page 59. • Adjust [Color balance] in [Adjustment]. See page 53.
Image isn't square to the screen	<ul style="list-style-type: none"> • Reposition the projector to improve its angle to the screen. See page 28. • Use the Keystone correction function to correct the trapezoid distortion. See page 31.
Picture is blurred	<ul style="list-style-type: none"> • Adjust the focus. See page 29. • Reposition the projector to improve its angle to the screen. See page 28. • Ensure that the distance between the projector and screen is within the adjustment range of the lens. See page 11, 12, 82, 83. • Condensation may form on the lens if the projector is cold, brought into a warm place and is then turned on. Should this happen, let the projector stand until there is no condensation on the lens.
Picture is distorted	<ul style="list-style-type: none"> • Make sure the VGA cable is connected. • Press the AUTO PC button on the projector cabinet or the remote control. See page 34.
Flicker appears on screen	<ul style="list-style-type: none"> • Set [Fan mode] to other mode than [High altitude] when using the projector at altitudes approximately 5500 feet/1600 meters or lower. Using the projector at altitudes less than approximately 5500 feet/1600 meters and setting to [High altitude] can cause the lamp to overcool, causing the image to flicker. Switch [Fan mode] to [Auto] or [High]. See page 63.
Image is scrolling vertically, horizontally or both	<ul style="list-style-type: none"> • Use the INPUT button to select your source. See page 26. • Adjust the computer image manually with the [Horizontal position] or [Vertical position] in the [Adjustment] → [Input signal]. See page 55.
Remote control does not work	<ul style="list-style-type: none"> • Install new batteries. See page 9. • Make sure there are no obstacles between you and the projector. • Stand within 7 m (22 feet) of the projector. See page 9.
Indicator is lit or blinking	<ul style="list-style-type: none"> • See the POWER/STATUS/LAMP Indicator on page 74.
Cross color in RGB mode	<ul style="list-style-type: none"> • Press the AUTO PC button on the projector cabinet or the remote control. See page 34. • Adjust the computer image manually with [Clock] or [Tracking] in [Input signal] in the menu. See page 54.
Whenever the projector is turned on, a message prompting you to clean the filter will be displayed	<ul style="list-style-type: none"> • Clean or replace the filter and then reset the Filter counter. See page 69, 68. • Press any button on the remote control or the projector cabinet to clear the message.
The projector is behaving in an erratic way	<ul style="list-style-type: none"> • Turn off the main power and disconnect the power cord. Allow 5 minutes and then plug the power cord and turn on the main power.
The [Projector overheating! See the user's manual.] message is displayed.	<ul style="list-style-type: none"> • Check for any obstacle at ventilation(inlet) of the rear. If there is an obstacle, remove it or relocate the projector to an area with proper ventilation. If the filter is dirty or clogged, clean or replace the filter. After cleaning or replacing the filter, reset the [Filter counter]. See page 69, 68.

For more information contact your dealer.

If there is no picture, or the picture is not displayed correctly.

- Power on process for the projector and the PC.

Be sure to connect the VGA cable between the projector and the computer before turning on the computer. There are some notebook PCs, which do not output signal unless there is a projector or monitor connected first.

NOTE: You can check the horizontal frequency of the current signal in the projector's menu under Information. If it reads "0kHz", this means there is no signal being output from the computer. See page 67 or go to next step.

- Enabling the computer's external display.

Displaying an image on the notebook PC's screen does not necessarily mean it outputs a signal to the projector. When using a PC compatible laptop, a combination of function keys will enable/disable the external display. Usually, the combination of the 'Fn' key along with one of the 12 function keys gets the external display to come on or off. For more details, refer to your computer's owner's manual.

- Non-standard signal output from the computer

If the output signal from a notebook PC is not an industry standard, the projected image may not be displayed correctly. Should this happen, deactivate the notebook PC's LCD screen when the projector display is in use. Each notebook PC has a different way of deactivate/reactivate the local LCD screens as described in the previous step. Refer to your computer's documentation for detailed information.

- Image displayed is incorrect when using a Macintosh

When using a Macintosh with the projector, set the DIPswitch of the Mac adapter (not supplied with the projector) according to your resolution. After setting, restart your Macintosh for the changes to take affect.

For setting display modes other than those supported by your Macintosh and the projector, changing the DIP switch on a Mac adapter may bounce an image slightly or may display nothing. Should this happen, set the DIP switch to the 13" fixed mode and then restart your Macintosh. After that, restore the DIP switches to a displayable mode and then restart the Macintosh again.

NOTE: A Video Adapter cable manufactured by Apple Inc. is needed for a PowerBook which does not have a mini D-Sub 15-pin connector.

- Mirroring on a PowerBook

- * When using the projector with a Macintosh PowerBook, output may not be set to 1024 x 768 unless "mirroring" is off on your PowerBook. Refer to owner's manual supplied with your Macintosh computer for mirroring.

- Folders or icons are hidden on the Macintosh screen

Folders or icons may not be seen on the screen. Should this happen, select [View] → [Arrange] from the Apple menu and arrange icons.

② Specifications

This section provides technical information about the projector's performance.

Model Name LV-7385/LV-7380/LV-7285/LV-7280/LV-8310/LV-8215

Optical

	LV-7385	LV-7380	LV-7285	LV-7280	LV-8310	LV-8215
LCD Panel	0.63" p-Si TFT active-matrix with Micro Lens Array (Aspect 4:3)		0.63" p-Si TFT active-matrix (Aspect 4:3)		0.59" p-Si TFT active-matrix with Micro Lens Array (Aspect 16:10)	
Resolution	1024 x 768 pixels*1 native, up to UXGA with scaling technology (up to SXGA + 1400 dot(H) X 1050dot(V) Max. at RGB digital)				1280 x 800 pixels*1 native, up to UXGA with scaling technology	
Lens	Manual zoom and manual focus F1.7 - 2.0 f = 19.8 - 23.7 mm					
Lamp	230W AC lamp (170W in Quiet mode)	180W AC lamp (145W in Quiet mode)			230W AC lamp (170W in Quiet mode)	
Brightness*2 (Presentation mode)	3500 lm	3000 lm	2600 lm	2200 lm	3000 lm	2600 lm
Contrast Ratio*2 (full white: full black) (Presentation mode)	500:1		2000:1*3		500:1	450:1
Uniformity (Presentation mode)	85%					
Image Size (Diagonal)	21" to 300"/0.53 m to 7.6 m					
Projection Distance	0.8 m to 11.3 m/31.5" to 444.9"				0.8m to 11.95m/31.5" to 470.5"	
Projection Angle	Tele: 7.9°- 8.3°/ Wide: 9.5°- 9.9°				Tele: 8.0°- 8.3°/ Wide: 9.6°- 9.9°	
Keystone Correction	+/- 30° Vertical (Auto keystone)					

*1 Effective pixels are more than 99.99%.

*2 Compliance with ISO21118-2005"

*3 The value is measured when [Auto iris] is set to [On].

Electrical

	LV-7385	LV-7380	LV-7285	LV-7280	LV-8310	LV-8215
Inputs	1 RGB/Component (D-Sub 15 Pin), 1 RGB (Digital/Analog, DVI-29 P, HDCP*4 supported), 1 S-Video (DIN 4 Pin), 1 Video (RCA), 1(L/R) RCA Audio, 2 Stereo Mini Audio					
Outputs	1 RGB (D-Sub 15 Pin), 1 Stereo Mini Audio					
Wired LAN Port	RJ-45					
Video Compatibility	NTSC, NTSC4.43, PAL, PAL-60, PAL-N, PAL-M, SECAM, 1080i, 720p, 480p, 480i /60Hz 1080i, 576p, 576i /50Hz					
Scan Rate	Horizontal: 15 kHz to 100 kHz (RGB: 24 kHz or over) Vertical: 50 Hz to 120 Hz					
Video Bandwidth	RGB: 80 MHz (-3dB)					
Color Reproduction	16.77 million colors simultaneously, Full color					
Horizontal Resolution	NTSC/NTSC4.43/PAL/PAL-M/PAL-N/PAL60/YCbCr: 540 TV lines SECAM: 300 TV lines RGB: 1024 dots (H) x 768 dots (V)				RGB: 1280 dots (H) x 800 dots (V)	
External Control	RS232, IR, Wired LAN					
Sync Compatibility	Separate Sync / Composite Sync / Sync on Green					
Built-in Speaker	7W (monaural)					
Power Requirement	LV-7385/LV-7380/LV-7285/LV-7280/LV-8310/LV-8215: 100 - 240V AC, 50 / 60 Hz LV-7385(E)/LV-7380(E)/LV-7285(E)/LV-7280(E)/LV-8310(E)/LV-8215:(E): 200 - 240V AC, 50 / 60 Hz					
Input Current	LV-7385: 3.8-1.5A LV-7385(E): 1.8A	LV-7380/LV-7285/LV-7280: 3.2-1.4A LV-7380(E)/LV-7285(E)/LV-7280(E): 1.5A			LV-8310/LV-8215: 3.8-1.5A LV-8310(E)/LV-8215(E): 1.8A	

		LV-7385	LV-7380	LV-7285	LV-7280	LV-8310	LV-8215
Power Consumption	100V AC	0.6W in Power-saving mode / 10W in Standby mode / 312W in Lamp Normal mode / 237W in Lamp Quiet mode	0.6W in Power-saving mode / 10W in Standby mode / 251W in Lamp Normal mode / 203W in Lamp Quiet mode			0.6W in Power-saving mode / 10W in Standby mode / 312W in Lamp Normal mode / 237W in Lamp Quiet mode	
	200V AC	0.7W in Power-saving mode / 10W in Standby mode / 294W in Lamp Normal mode / 228W in Lamp Quiet mode	0.7W in Power-saving mode / 10W in Standby mode / 239W in Lamp Normal mode / 195W in Lamp Quiet mode			0.7W in Power-saving mode / 10W in Standby mode / 294W in Lamp Normal mode / 228W in Lamp Quiet mode	

*4 What is HDCP/HDCP technology?

HDCP is an acronym for High-bandwidth Digital Content Protection. High bandwidth Digital Content Protection (HDCP) is a system for preventing illegal copying of video data sent over a Digital Visual Interface (DVI).

If you are unable to view material via the DVI input, this does not necessarily mean the projector is not functioning properly.

With the implementation of HDCP, there may be cases in which certain content is protected with HDCP and might not be displayed due to the decision/intention of the HDCP community (Digital Content Protection, LLC).

Mechanical

	LV-7385	LV-7380	LV-7285	LV-7280	LV-8310	LV-8215
Installation	Orientation: Front / Rear / Ceiling mounted / Rear, Ceiling mounted					
Dimensions	12.5"(W) x 13.2"(D) x 4.4"(H) 317 mm (W) x 336 mm (D) x 111 mm (H) (not including protrusions)					
Weight	7.3 lbs / 3.3 kg					
Fan Noise	35 dB (Normal mode), 29dB (Quiet mode)					
Environmental Considerations	Operational Temperatures : 41° to 104°F (5° to 40°C), (Quiet mode selected automatically at 95°F to 104°F / 35°C to 40°C) 20% to 80% humidity (non-condensing) Storage Temperatures : 14° to 122°F (-10° to 50°C), 20% to 80% humidity (non-condensing)					

Regulations

For United States:
 UL Approved (UL 60950-1)
 Meets FCC Class B requirements

For Canada:
 UL Approved (CSA 60950-1)
 Meets DOC Canada Class B requirements

For Australia/New Zealand:
 Meets AS/NZS CISPR.22 Class B

For Europe:
 Meets EMC Directive (EN55022, EN55024, EN61000-3-2, EN61000-3-3)
 Meets Low Voltage Directive (EN60950-1)



The specifications are subject to change without notice.

3 Cabinet Dimensions

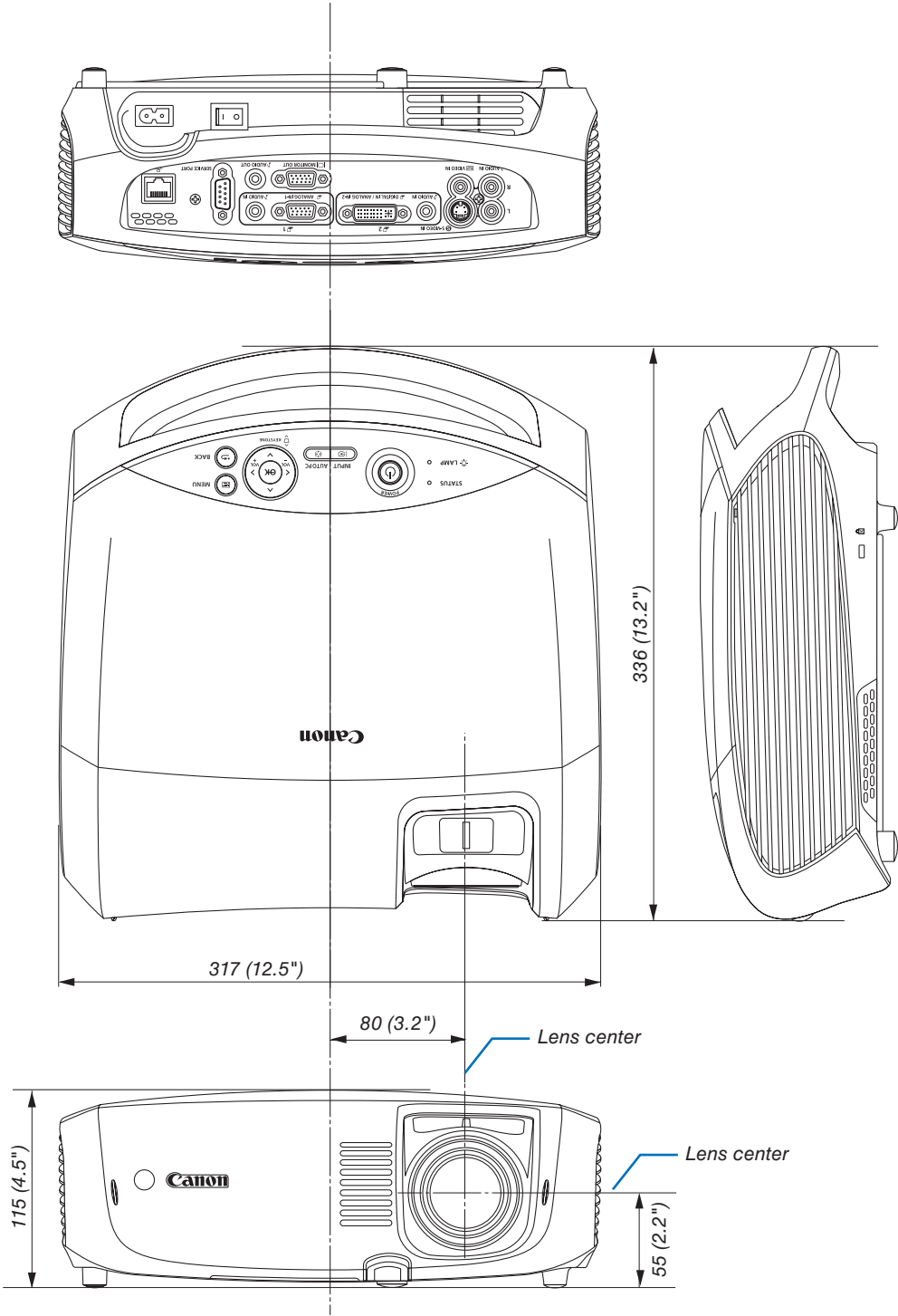

Unit: mm (inch)

④ Pin Assignments of D-Sub ANALOG IN-1 Input Connector

Mini D-Sub 15 Pin Connector

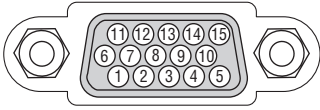

Signal Level

Video signal : 0.7Vp-p (Analog)

Sync signal : TTL level

Pin No.	RGB Signal (Analog)	YCbCr Signal
1	Red	Cr
2	Green or Sync on Green	Y
3	Blue	Cb
4	Ground	
5	Ground	
6	Red Ground	Cr Ground
7	Green Ground	Y Ground
8	Blue Ground	Cb Ground
9	No Connection	
10	Sync Signal Ground	
11	No Connection	
12	Bi-directional DATA (SDA)	
13	Horizontal Sync or Composite Sync	
14	Vertical Sync	
15	Data Clock	

5 Compatible Input Signal List

Horizontal: 15KHz to 100KHz (RGB: 24KHz or over)

Vertical: 50Hz to 120Hz

Signal		Resolution (Dots)	Frequency H. (kHz)	Refresh Rate (Hz)
VIDEO	NTSC	- *	15.7	59.9
	PAL	- *	15.6	50.0
	PAL60	- *	15.7	60.0
	SECAM	- *	15.6	50.0
VGA	640 × 480	31.5	59.9	
	640 × 480	31.5	60.0	
	640 × 480	37.9	72.8	
	640 × 480	37.5	75.0	
	640 × 480	39.4	75.0	
	640 × 480	43.3	85.0	
SVGA	800 × 600	35.2	56.3	
	800 × 600	37.9	60.3	
	800 × 600	48.1	72.2	
	800 × 600	46.9	75.0	
	800 × 600	53.7	85.1	
XGA	1024 × 768	48.4	60.0	
	1024 × 768	56.5	70.1	
	1024 × 768	60.0	75.0	
	1024 × 768	68.7	85.0	
WXGA	1280 × 768	47.8	59.9	
	1280 × 800	49.7	59.8	
-	1152 × 864	54.4	60.1	
	1152 × 864	64.0	70.0	
	1152 × 864	67.5	75.0	
	1152 × 864 *	77.5	85.1	
-	1280 × 960	60.0	60.0	
	1280 × 960 *	75.0	75.0	
	1280 × 960 *	85.9	85.0	
SXGA	1280 × 1024	64.0	60.0	
	1280 × 1024 *	80.0	75.0	
	1280 × 1024 *	91.2	85.0	
SXGA+	1400 × 1050	64.7	60.0	
	1400 × 1050 *	65.3	60.0	
WXGA+	1440 × 900 *	55.9	59.9	
UXGA	1600 × 1200 *	75.0	60.0	
	1600 × 1200 *	81.3	65.0	
	1600 × 1200 *	87.5	70.0	
	1600 × 1200 *	93.8	75.0	
MAC13	640 × 480	35.0	66.7	
MAC16	832 × 624	49.7	74.6	
MAC19	1024 × 768	60.2	74.9	
MAC21	1152 × 870	68.7	75.1	
MAC	1280 × 1024	64.3	60.4	
	1280 × 1024 *	69.9	65.2	
	1280 × 1024 *	78.4	73.7	
HDTV	1080i/60	1920 × 1080	33.8	60.0
	1080i/50	1920 × 1080	28.1	50.0
	720p	1280 × 720	45.0	60.0
DVD	480i	720 × 480 *	15.7	59.9
	576i	720 × 576 *	15.6	50.0
	480p	720 × 480	31.5	59.9
	576p	720 × 576	31.3	50.0

NOTE:

- Images above flagged with "*" are not supported by digital signal.
- An image with higher or lower resolution than the projector's native resolution (LV-7385/LV-7380/LV-7285/LV-7280: 1024 x 768 / LV-8310/LV-8215: 1280 x 800) will be displayed with scaling technology.
- Some composite sync signals may not be displayed correctly.
Signals other than those specified in the table above may not be displayed correctly. If this should happen, change the refresh rate or resolution on your PC. Refer to Display Properties help section of your PC for procedures.

⑥ Relationship between Screen Size and Projection distance

LV-7385/LV-7380/LV-7285/LV-7280

Screen size at 4:3 aspect ratio WxD(cm)		Zoomed projection distance		H1	H2	Screen size at 16:10 aspect ratio WxD(cm)	
		Max.	Min.				
21"	43 × 32	-	0.8m (2.6')	27cm (0.9')	5cm (0.2')	20"	43 × 27
25"	51 × 38	0.8m (2.6')	0.9m (3.0')	32cm (1.1')	6cm (0.2')	24"	51 × 32
30"	61 × 46	0.9m (3.0')	1.1m (3.6')	39cm (1.3')	7cm (0.2')	28"	61 × 38
40"	81 × 61	1.2m (3.9')	1.5m (4.9')	51cm (1.7')	10cm (0.3')	38"	81 × 51
50"	102 × 76	1.5m (4.9')	1.9m (6.2')	64cm (2.1')	12cm (0.4')	47"	102 × 64
60"	122 × 91	1.9m (6.2')	2.2m (7.2')	77cm (2.5')	14cm (0.5')	57"	122 × 76
70"	142 × 107	2.2m (7.2')	2.6m (8.5')	90cm (3.0')	17cm (0.5')	66"	142 × 89
80"	163 × 122	2.5m (8.2')	3.0m (9.8')	103cm (3.4')	19cm (0.6')	76"	163 × 102
90"	183 × 137	2.8m (9.2')	3.4m (11.2')	116cm (3.8')	21cm (0.7')	85"	183 × 114
100"	203 × 152	3.1m (10.2')	3.7m (12.1')	129cm (4.2')	24cm (0.8')	94"	203 × 127
110"	224 × 168	3.4m (11.2')	4.1m (13.5')	141cm (4.6')	26cm (0.9')	104"	224 × 140
120"	244 × 183	3.7m (12.1')	4.5m (14.8')	154cm (5.1')	29cm (0.9')	113"	244 × 152
130"	264 × 198	4.0m (13.1')	4.9m (16.1')	167cm (5.5')	31cm (1.0')	123"	264 × 165
140"	285 × 213	4.4m (14.4')	5.2m (17.1')	180cm (5.9')	33cm (1.1')	132"	285 × 178
150"	305 × 229	4.7m (15.4')	5.6m (18.4')	193cm (6.3')	36cm (1.2')	142"	305 × 191
160"	325 × 244	5.0m (16.4')	6.0m (19.7')	206cm (6.8')	38cm (1.3')	151"	325 × 203
170"	345 × 259	5.3m (17.4')	6.4m (21.0')	219cm (7.2')	41cm (1.3')	160"	345 × 216
176"	358 × 268	5.5m (18.0')	6.6m (21.7')	226cm (7.4')	42cm (1.4')	166"	358 × 224
180"	366 × 274	5.6m (18.4')	6.8m (22.3')	231cm (7.6')	43cm (1.4')	170"	366 × 229
190"	386 × 290	5.9m (19.4')	7.1m (23.3')	244cm (8.0')	45cm (1.5')	179"	386 × 241
200"	406 × 305	6.2m (20.3')	7.5m (24.6')	257cm (8.4')	48cm (1.6')	189"	406 × 254
210"	427 × 320	6.6m (21.7')	7.9m (25.9')	270cm (8.9')	50cm (1.6')	198"	427 × 267
220"	447 × 335	6.9m (22.6')	8.3m (27.2')	283cm (9.3')	52cm (1.7')	208"	447 × 279
230"	467 × 351	7.2m (23.6')	8.6m (28.2')	296cm (9.7')	55cm (1.8')	217"	467 × 292
240"	488 × 366	7.5m (24.6')	9.0m (29.5')	309cm (10.1')	57cm (1.9')	226"	488 × 305
250"	508 × 381	7.8m (25.6')	9.4m (30.8')	321cm (10.5')	60cm (2.0')	236"	508 × 318
260"	528 × 396	8.1m (26.6')	9.8m (32.2')	334cm (11.0')	62cm (2.0')	245"	528 × 330
270"	549 × 412	8.4m (27.6')	10.1m (33.1')	347cm (11.4')	64cm (2.1')	255"	549 × 343
280"	569 × 427	8.8m (28.9')	10.5m (34.5')	360cm (11.8')	67cm (2.2')	264"	569 × 356
290"	589 × 442	9.1m (29.9')	10.9m (35.8')	373cm (12.2')	69cm (2.3')	274"	589 × 368
300"	610 × 457	9.4m (30.8')	11.3m (37.1')	386cm (12.7')	71cm (2.3')	283"	610 × 381

LV-8310/LV-8215

Screen size at 16:10 aspect ratio WxD(cm)		Zoomed projection distance		H1	H2	Screen size at 4:3 aspect ratio WxD(cm)	
		Max.	Min.				
21"	45 × 28	-	0.8m (2.6')	26cm (0.8')	2cm (0.1')	19"	38 × 28
25"	54 × 34	0.8m (2.6')	1.0m (3.2')	31cm (1.0')	3cm (0.1')	22"	45 × 34
30"	65 × 40	1.0m (3.2')	1.2m (3.8')	37cm (1.2')	4cm (0.1')	26"	54 × 40
40"	86 × 54	1.3m (4.2')	1.6m (5.1')	49cm (1.6')	5cm (0.2')	35"	72 × 54
50"	108 × 67	1.6m (5.3')	2.0m (6.4')	61cm (2.0')	6cm (0.2')	44"	90 × 67
60"	129 × 81	2.0m (6.4')	2.4m (7.7')	74cm (2.4')	7cm (0.2')	53"	108 × 81
70"	151 × 94	2.3m (7.5')	2.8m (9.1')	86cm (2.8')	8cm (0.3')	62"	126 × 94
80"	172 × 108	2.6m (8.6')	3.2m (10.4')	98cm (3.2')	9cm (0.3')	71"	144 × 108
90"	194 × 121	3.0m (9.7')	3.6m (11.7')	111cm (3.6')	11cm (0.3')	79"	162 × 121
100"	215 × 135	3.3m (10.8')	4.0m (13.0')	123cm (4.0')	12cm (0.4')	88"	179 × 135
110"	237 × 148	3.6m (11.9')	4.4m (14.3')	135cm (4.4')	13cm (0.4')	97"	197 × 148
120"	258 × 162	4.0m (13.0')	4.8m (15.6')	147cm (4.8')	14cm (0.5')	106"	215 × 162
130"	280 × 175	4.3m (14.1')	5.2m (16.9')	160cm (5.2')	15cm (0.5')	115"	233 × 175
140"	302 × 188	4.6m (15.2')	5.6m (18.2')	172cm (5.6')	16cm (0.5')	124"	251 × 188
150"	323 × 202	5.0m (16.3')	6.0m (19.5')	184cm (6.0')	18cm (0.6')	132"	269 × 202
160"	345 × 215	5.3m (17.4')	6.4m (20.9')	197cm (6.4')	19cm (0.6')	141"	287 × 215
170"	366 × 229	5.6m (18.4')	6.8m (22.2')	209cm (6.9')	20cm (0.7')	150"	305 × 229
176"	379 × 237	5.8m (19.1')	7.0m (23.0')	216cm (7.1')	21cm (0.7')	155"	316 × 237
180"	388 × 242	6.0m (19.5')	7.2m (23.5')	221cm (7.3')	21cm (0.7')	159"	323 × 242
190"	409 × 256	6.3m (20.6')	7.6m (24.8')	233cm (7.7')	22cm (0.7')	168"	341 × 256
200"	431 × 269	6.6m (21.7')	8.0m (26.1')	246cm (8.1')	24cm (0.8')	177"	359 × 269
210"	452 × 283	7.0m (22.8')	8.4m (27.4')	258cm (8.5')	25cm (0.8')	185"	377 × 283
220"	474 × 296	7.3m (23.9')	8.8m (28.7')	270cm (8.9')	26cm (0.9')	194"	395 × 296
230"	495 × 310	7.6m (25.0')	9.2m (30.0')	283cm (9.3')	27cm (0.9')	203"	413 × 310
240"	517 × 323	8.0m (26.1')	9.6m (31.3')	295cm (9.7')	28cm (0.9')	212"	431 × 323
250"	538 × 337	8.3m (27.2')	10.0m (32.7')	307cm (10.1')	29cm (1.0')	221"	449 × 337
260"	560 × 350	8.6m (28.3')	10.4m (34.0')	319cm (10.5')	31cm (1.0')	230"	467 × 350
270"	582 × 363	9.0m (29.4')	10.8m (35.3')	332cm (10.9')	32cm (1.0')	238"	485 × 363
280"	603 × 377	9.3m (30.5')	11.2m (36.6')	344cm (11.3')	33cm (1.1')	247"	503 × 377
290"	625 × 390	9.6m (31.6')	11.6m (37.9')	356cm (11.7')	34cm (1.1')	256"	521 × 390
300"	646 × 404	9.9m (32.6')	12.0m (39.2')	369cm (12.1')	35cm (1.2')	265"	538 × 404

7 PC Control Codes and Cable Connection

PC Control Codes

Function	Code Data					
POWER ON	02H	00H	00H	00H	00H	02H
POWER OFF	02H	01H	00H	00H	00H	03H
INPUT SELECT Computer 1	02H	03H	00H	00H	02H	01H 01H 09H
INPUT SELECT Computer 2 (Digital)	02H	03H	00H	00H	02H	01H 1AH 22H
INPUT SELECT Computer 2 (Analog)	02H	03H	00H	00H	02H	01H 02H 0AH
INPUT SELECT VIDEO	02H	03H	00H	00H	02H	01H 06H 0EH
INPUT SELECT S-VIDEO	02H	03H	00H	00H	02H	01H 0BH 13H
BLANK ON	02H	10H	00H	00H	00H	12H
BLANK OFF	02H	11H	00H	00H	00H	13H
SOUND MUTE ON	02H	12H	00H	00H	00H	14H
SOUND MUTE OFF	02H	13H	00H	00H	00H	15H

NOTE: Contact your local dealer for a full list of the PC Control Codes if needed.

Cable Connection

Communication Protocol

Baud rate.....19200 bps
 Data length.....8 bits
 Parity.....No parity
 Stop bit.....One bit
 X on/offNone
 Communications procedure.....Full duplex

NOTE: Depending on the equipment, a lower baud rate may be recommended for long cable runs.

SERVICE PORT Connector (D-SUB 9P)

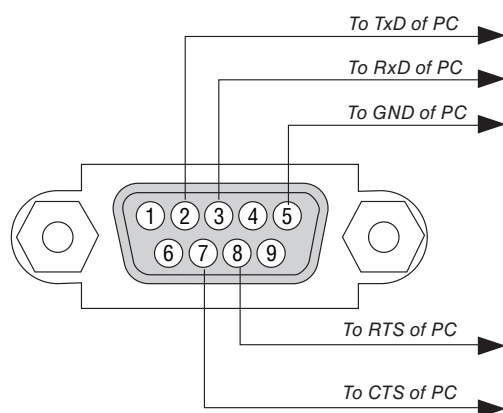

NOTE 1: Pins 1, 4, 6 and 9 are no used.

NOTE 2: Jumper "Request to Send" and "Clear to Send" together on both ends of the cable to simplify cable connection.

NOTE 3: For long cable runs it is recommended to set communication speed within projector menus to 9600 bps.

8 Troubleshooting Check List

Before contacting your dealer or service personnel, check the following list to be sure repairs are needed, you may also refer to the “Troubleshooting” section in your user’s manual. This checklist below will help us solve your problem more efficiently.

* Print the following pages.

Frequency of occurrence always sometimes (How often? _____) other (_____)

Power

- No power (POWER indicator does not light green) See also “STATUS Indicator”.
 - Power cord’s plug is fully inserted into the wall outlet.
 - Main power switch is pressed to the ON position.
 - Lamp cover is installed correctly .
 - Lamp counter (lamp operation hours) was cleared after lamp replacement.
 - No power even though you press and hold the POWER button for a minimum of 1 second.
- Shut down during operation.
 - Power cord’s plug is fully inserted into the wall outlet.
 - Lamp cover is installed correctly .
 - Power Management is turned off (only models with the Power Management function).
 - Off timer is turned off (only models with the Off timer function).

Video and Audio

- No image is displayed from your PC or video equipment to the projector.
 - Still no image even though you connect the projector to the PC first, then start the PC.
 - Enabling your notebook PC’s signal output to the projector.
 - *A combination of function keys will enable/disable the external display. Usually, the combination of the “Fn” key along with one of the 12 function keys turns the external display on or off.*
 - No image (blue background, logo, no display).
 - Still no image even though you press the AUTO PC button.
 - Still no image even though you carry out “Reset” in the projector’s menu.
 - Signal cable’s plug is fully inserted into the input connector
 - A message appears on the screen. (_____)
 - The source connected to the projector is active and available.
 - Still no image even though you adjust the brightness and/or the contrast.
 - Input source’s resolution and frequency are supported by the projector.
- Image is too dark.
 - Remains unchanged even though you adjust the brightness and/or the contrast.
- Image is distorted.
 - Image appears to be trapezoidal (unchanged even though you carry out the “Keystone adjustment”).
- Parts of the image are lost.
 - Still unchanged even though you press the AUTO PC button.
 - Still unchanged even though you carry out “Reset” in the projector’s menu.
- Image is shifted in the vertical or horizontal direction.
 - Horizontal and vertical positions are correctly adjusted on a computer signal.
 - Input source’s resolution and frequency are supported by the projector.
 - Some pixels are lost.
- Image is flickering.
 - Still unchanged even though you press the AUTO PC button.
 - Still unchanged even though you carry out “Reset” in the projector’s menu.
 - Image shows flickering or color drift on a computer signal.
 - Still unchanged even though you change [Fan mode] from [High altitude] to [Auto].
- Image appears blurry or out of focus.
 - Still unchanged even though you checked the signal’s resolution on PC and changed it to projector’s native resolution.
 - Still unchanged even though you adjusted the focus.
- No sound.
 - Audio cable is correctly connected to the audio input of the projector.
 - Still unchanged even though you adjusted the volume level.
 - AUDIO OUT is connected to your audio equipment (only models with the AUDIO OUT connector).

Other

- Remote control does not work.
 - No obstacles between the sensor of the projector and the remote control.
 - Projector is placed near a fluorescent light that can disturb the infrared remote controls.
 - Batteries are new and are not reversed in installation.
- Buttons on the projector cabinet do not work (only models with the Key lock function).
 - Key lock is not turned on or is disabled in the menu.
 - Still unchanged even though you press and hold the BACK button for a minimum of 10 seconds.

In the space below please describe your problem in detail.

Information on application and environment where your projector is used

Projector

Model name:

Serial No.:

Date of purchase:

Lamp operating time (hours):

Lamp Mode: Normal Quiet

Information on input signal:

Horizontal sync frequency [] kHz

Vertical sync frequency [] Hz

Sync polarity H (+) (-)

V (+) (-)

Sync type Separate Composite

Sync on Green

STATUS Indicator:

Steady light Orange Green

Flashing light [] cycles

Remote control model number:

Installation environment

Screen size: inch

Screen type: White matte Beads Polarization
 Wide angle High contrast

Throw distance: feet/inch/m

Orientation: Ceiling mount Desktop

Power outlet connection:

Connected directly to wall outlet

Connected to power cord extender or other (the number of connected equipment _____)

Connected to a power cord reel or other (the number of connected equipment _____)

Computer

Manufacturer:

Model number:

Notebook PC / Desktop

Native resolution:

Refresh rate:

Video adapter:

Other:

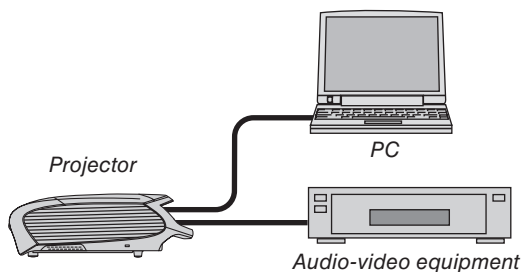

Signal cable

Canon standard or other manufacturer's cable?

Model number: Length: inch/m

Distribution amplifier

Model number:

Switcher

Model number:

Adapter

Model number:

Audio-video equipment

VCR, DVD player, Video camera, Video game or other

Manufacturer:

Model number:

**CANON INC.**

30-2, Shimomaruko 3-chome, Ohta-ku, Tokyo
146-8501, Japan

U.S.A.

CANON U.S.A. INC.

One Canon Plaza, Lake Success, NY 11042-
1198, U.S.A.

For all inquires concerning this product, call toll
free in the U.S.

1-800-OK-CANON

CANADA

CANON CANADA INC. HEADQUARTERS

6390 Dixie Road, Mississauga, Ontario L5T
1P7, Canada

CANON CANADA INC. MONTREAL BRANCH

5990, Côte-de-Liesse, Montréal Québec H4T
1V7, Canada

CANON CANADA INC. CALGARY OFFICE

2828, 16th Street, N.E. Calgary, Alberta T2E
7K7, Canada

For all inquiries concerning this product, call toll
free in Canada

1-800-OK-CANON

EUROPE, AFRICA & MIDDLE EAST

CANON EUROPE LTD.

3 The Square, Stockley Park, Uxbridge, Middlesex,
UB11 1ET United Kingdom

CANON EUROPA N.V.

Bovenkerkerweg 59-61, 1185 XB Amstelveen,
The Netherlands

CANON FRANCE S.A.S

17, quai du President Paul Doumer, 92414
Courbevoie Cedex, France

CANON UK LTD.

Woodhatch Reigate Surrey RH2 8BF, United Kingdom

CANON DEUTSCHLAND GmbH

Europark Fichtenhain A10, 47807 Krefeld, Germany

CANON ITALIA S.p.A.

Via Milano 8 I-20097 San Donato Milanese, Milano, Italy

CANON Schweiz AG

Geschäftsbereich Wiederverkauf, Industriestrasse
12, CH-8305 Dietlikon, Switzerland

CANON GMBH

Zetschegasse 11, A-1230 Wien, Austria

CANON España, S.A.

C/Joaquín Costa, 41, 28002 Madrid, Spain

CANON PORTUGAL S.A.

Rua Alfredo da Silva, 14 Alfragide 2610-016
Amadora, Portugal

CANON Belgium N.V./S.A.

Berkenlaan 3, 1831 Diegem (Mechelen), Belgium

CANON Netherland NV

Neptunusstraat 1, 2132 JA Hoofddorp, The
Netherlands

CANON LUXEMBOURG S.A.

Rue des Joncs 21, L-1818 Howald, Luxembourg

CANON DANMARK A/S

Knud Hoejgaards Vej 1 DK-2860 Soeborg, Dan-
mark

CANON OY

Huopalahdentie 24 PL 1 00351 Helsinki, Finland

CANON SVENSKA AB

Gustav III:s Boulevard 26 169 88 Solna, Sweden

CANON NORGE as

Hallagerbakken 110, Postboks 33, Holmlia,
1201 Oslo, Norway

CENTRAL & SOUTH AMERICA

CANON LATIN AMERICA, INC.

703 Waterford Way, Ste. 400 Miami, FL 33126,
U.S.A.

ASIA

CANON (China) Co., Ltd.

15F Jinbao Building No.89 Jinbao Street,
Dongcheng District, Beijing 100005, China

CANON HONGKONG CO., LTD.

19/F., The Metropolis Tower, 10 Metropolis
Drive, Hunghom, Kowloon, Hong Kong

CANON SINGAPORE PTE. LTD.

1 HarbourFront Avenue, #04-01 Keppel Bay
Tower, Singapore 098632

CANON KOREA CONSUMER IMAGING INC.

Gangnam Finance Center 17F,737,Yeoksam-
Dong, Gangnam-gu, Seoul, 135-984, Korea

OCEANIA

CANON AUSTRALIA PTY. LTD.

1 Thomas Holt Drive, North Ryde, N.S.W. 2113,
Australia

CANON NEW ZEALAND LTD.

Akoranga Business Park, Akoranga Drive,
Northcote, Auckland, New Zealand